

The LEDcode-Casambi BLE wireless control modules by eldoLED are 2-way digital devices, designed for integration into your luminaire. They can be connected to any eldoLED DALI-2 LED driver with LEDcode2 interface to provide a seamless integration into a Casambi BLE network. Commissioning can be done via the Casambi App. These products merge Quality of Light with wireless control.

The wireless control modules receive power and data via the LEDcode2 connection to the driver. Combined with an eldoLED LED driver, these miniaturized low-voltage devices enable simple wireless control of individual luminaires, groups of luminaires using LEDcode Cross and room control.

The product family includes wireless control modules in 3 different form factors (linear shape with or without external antenna, and flush-mount shape). The modules can be equipped with different profiles for controlling single channel drivers (ECOdrive* and SOLOdrive*) or two channel drivers (DUALdrive* and LINEARdrive 200D models*).

The product family also includes BLE modules combined with integrated sensors for energy saving and room control. These products can either fit in a rectangular 17x44mm Zhaga cut-out or can be mounted with the lens receptacle in a round 16mm cut-out. They are available for IP20 rated luminaires as well as IP66 rated luminaires. The range includes PIR lenses for 3m as well as 6m mounting heights.

The family received a best-in-class rating by Casambi and has been designed to meet the standards in Europe (CE) as well as North America (UL).

Applications

- Indoor and architectural lighting with wireless control
- Office, education and commercial room, stairways and corridor control
- Waterproof luminaires for passages, garages and low-bay industrial applications with wireless corridor control

Key Features and Benefits

- Wireless control with Bluetooth (Casambi Ready)
- Quality of Light with BLE wireless control. Low-voltage BLE module that works with eldoLED DALI-2 drivers with a LEDcode2 interface of the following series:
 - ECOdrive (dim down to 1%)
 - SOLOdrive (dim down to 0.1%)
 - DUALdrive (Tunable White)
 - LINEARdrive 200D (CV applications)
See the reference table for more details.
- No additional mains voltage required.
- Miniaturized and minimalistic design enabling multiple ways to integrate the module in the luminaire. Available form factors include:
 - Linear shape with integrated antenna
 - Flush-mount shape with integrated antenna
 - Linear shape with external antenna
 - Zhaga book 20 shape (17x44mm) with sensors and option to mount in 16mm cut-out using lens receptacle
 - The sensor product range includes models for IP20 and for IP66 rated luminaires
 - Sensor product range includes models with presence detection optimized for 3m and 6m mounting height
- Multiple profiles are available to control:
 - 1 channel drivers (ECOdrive* and SOLOdrive*, LINEARdrive 200D*)
 - 2 channel drivers (DUALdrive*, LINEARdrive 200D*)
- Positive release tested by Casambi, enables use in an ecosystem with over 300 industry partners (e.g. wall switches)
- Cost-effective and commissioning-free group control can be enabled by the driver with LEDcode Cross. One driver (the driver with a wireless control module) broadcasts DALI commands to the other DALI drivers over the DALI line. The primary driver receives its control input via the LEDcode bus from the wireless control module.

* DALI-2 models with LEDcode2 interface

Specifications and Certifications

CASAMBI **LEDcode2**



BT Family Wireless Control – Datasheet

Products

Product**	Nominal Input over LEDcode2	Housing Form Factor	IP Rating	Mounting Height for Sensor	Compatible DALI-2 Drivers with LEDcode interface
BT-L2E1	5V 7mA	Linear*	IP20	-	ECOdrive, SOLOdrive, DUALdrive (DT6), LINEARdrive (DT6)
BT-S1E1	5V 7mA	Flush-mount	IP20	-	
BT-L1E-1w1	5V 7mA	Linear	IP20	-	ECOdrive, SOLOdrive, DUALdrive (DT6, DT8), LINEARdrive (DT6, DT8)
BT-L1E-1x1	5V 7mA	Linear	IP20	-	
BT-Z2E-3x1	5V 7mA	Zhaga	IP20	3m	
BT-Z2E-6x1	5V 7mA	Zhaga	IP20	6m	
BT-Z6E-3x1	5V 7mA	Zhaga	IP66	3m	
BT-Z6E-6x1	5V 7mA	Zhaga	IP66	6m	

* External antenna is linear PCB.

** All products have Evolution (E) Casambi stack as standard. The product is capable of OTA (over-the-air) updates. BT-L2E1, BT-S1E1 contain FCC ID: 2ADCB-BRM1, the other ones contain FCC ID: 2ALA3-CBM003B, contains IC (ISED): 22496-CBM003B

Ordering Guide

BT	Lx	E	1	W1	5400
Family	Housing type	Wireless Network Stack	Version	Connection	Profile
BLE radio	L1 = Linear with internal antenna L2 = Linear with external antenna S1 = Flush-mount with internal antenna Z2 = Zhaga for IP20 luminaire Z6 = Zhaga for IP66 luminaire	E = Casambi Evolution	1 = Version 1 3 = 3m ceiling sensor lens 6 = 6m ceiling sensor lens	W1 = Pre-wired X1 = Push-in connector on product	Profile number, see the table 'Profile Information' below

Profile Information

Number	Product	Driver	Control
5400	BT-L2E1, BT-S1E1	ECOdrive, SOLOdrive, LINEARdrive DT6	1 channel dim of intensity
5402	BT-L2E1, BT-S1E1	DUALdrive 2x DT6, LINEARdrive 2x DT6	2 channel dim of intensity
14106	BT-L2E1, BT-S1E1	DUALdrive 2x DT6, LINEARdrive 2x DT6	2 channel dim and CCT (2700-6500K)
5403	BT-L2E1, BT-S1E1		2 channel dim and CCT (3000-6500K)
5405	BT-L2E1, BT-S1E1		2 channel dim and CCT (3000-6500K)
38986	BT-L1E-1w1 BT-L1E-1x1	ECOdrive, SOLOdrive, LINEARdrive DT6	1 channel dim of intensity
39367		DUALdrive 2x DT6, LINEARdrive 2x DT6	2 channel dim of intensity
39369		DUALdrive 2x DT6, DUALdrive DT8 LINEARdrive 2x DT6, LINEARdrive DT8	2 channel dim and CCT (2700-6500K)
37313	BT-Z2E-3x1	ECOdrive, SOLOdrive, LINEARdrive DT6	1 channel sensor-driven dimming of intensity
44096	BT-Z2E-6x1	DUALdrive 2x DT6, LINEARdrive 2x DT6	2 channel dim of intensity
44097	BT-Z6E-3x1 BT-Z6E-6x1	DUALdrive 2x DT6, DUALdrive DT8 LINEARdrive 2x DT6, LINEARdrive DT8	2 channel dim and CCT (2700-6500K)

For other profiles, please contact your eldoLED sales representative.

BT Family Wireless Control – Datasheet

Electrical Specifications

	Input	Input Voltage Range	Maximum Input Power	Peak Current	Polarity	Radio Protocol	Line of Sight (open air)
BT-L2E1*	LEDcode2	4.0-6.5V	50mW	<15mA @3.6V	Protected against incorrect LEDcode wiring	BLE 4.0	45m
BT-S1E1							45m
BT-L1E-1w1		3.0- 5.5V	100mW	<20mA @startup		BLE 5.3	100m**
BT-L1E-1x1							100m**
BT-Z2E-3x1			500mW	<100mA @startup		70m-120m***	
BT-Z2E-6x1						70m-120m***	
BT-Z6E-3x1		70m-120m***					
BT-Z6E-6x1		70m-120m***					

* Remote antenna Pulse W3525B

** Line of Sight doubles in long range mode

*** Line of Sight 70m in a metal box, doubles in long range mode; 120m in plastic enclosure, doubles in long range mode.

Minimum and Maximum Ratings

Operating Ambient Temperature Range	-20°C - 50°C
Lifetime	50.000 hours

Wiring and Connector Lay Out

	BT-L2E1 BT-L1E-1w1	BT-S1E1	BT-L1E-1x1 BT-Z2E-3x1, BT-Z2E-6x1 BT-Z6E-3x1, BT-Z6E-6x1
Connector Type	n/a, pre-wired	Molex 43460-0201 female*	BT-L1E-1x1: WAGO 205-302, or alike BT-Z2E and BT-Z6E versions: Phoenix PTSM 1771091, or alike
Wire Type	Solid	Solid	Solid
Wire Dimensions	0.5mm ²	0.33mm ²	0.5mm ²
Wire Length	600mm	100mm	n/a
Wire Strip Length	6mm	n/a	6mm
Maximum Length to LED driver	3m	3m	3m

* Male part Molex 43465

BT Family Wireless Control – Datasheet

Wiring Diagram

ECOdrive, SOLOdrive, LINEARdrive 1 channel (DALI) (top view)

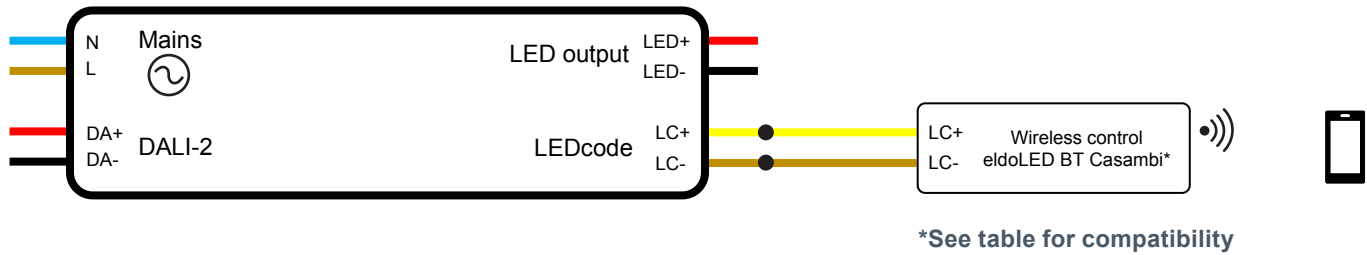

DUALdrive, SOLOdrive, LINEARdrive 2 channel (DALI) (top view)

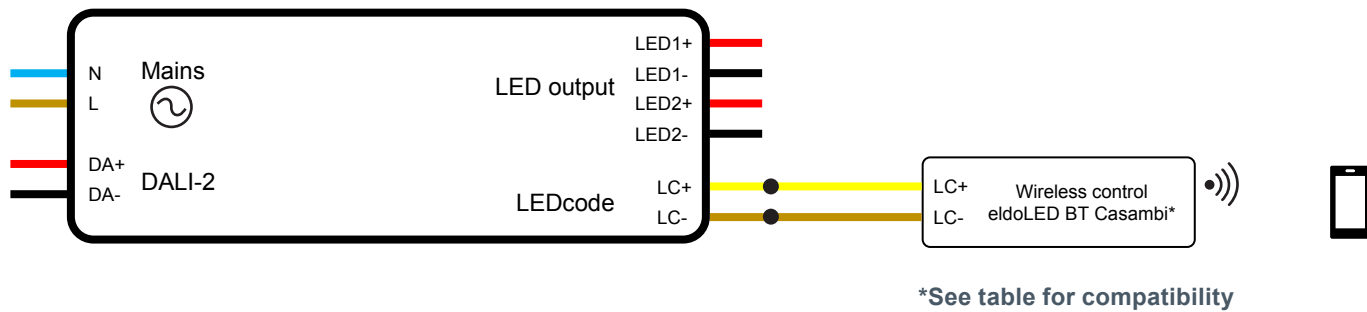

Compatibility Table

ECOdrive DALI	SOLOdrive DALI (1 or 2 channel) LINEARdrive DALI 1x DT6	DUALdrive DALI 2x DT6 LINEARdrive DALI 2x DT6	DUALdrive DALI DT8 LINEARdrive DALI DT8
BT-L1E-1w1	BT-L1E-1w1	BT-L1E-1w1	BT-L1E-1w1
BT-L1E-1w1	BT-L1E-1w1	BT-L1E-1w1	BT-L1E-1w1
BT-L2E1	BT-L2E1	BT-L2E1	
BT-S1E1	BT-S1E1	BT-S1E1	

BT Family Wireless Control – Datasheet

Mechanical Details

	BT-L2E1 (L2 x B x H)	BT-L1E-1x1 / 1w1 (L2 x B x H)	BT-S1E1 (L2 x Ø D3)	BT-Z2E-3x1 / 6x1 BT-Z6E-3x1 / 6x1 (L1 x B1 x H)
Dimensions	73 x 19 x 13mm	73 x 19 x 13mm	61 x 30mm	47 x 20 x 18mm (BT-Z2E) 47 x 20 x 21.4mm (BT-Z6E)
Screw Hole (d)	3.2mm	3.2mm	-	-
Mounting Screws	M3	M3	-	-
Torque	<100Nm	<100Nm	-	-
Antenna Connector	I-PEX-U.FL	-	-	-
Antenna Weight	3.3gr	-	-	-
Motion Sensor Detection Angle	-	-	-	PIR -45 .. +45 degrees, see PIR angular sensitivity graph
Light Sensor* Detection Range	-	-	-	Photocell 10-2000 lux
Zhaga Cut-out Mount (LEX-S Zhaga book 20)	-	-	-	17 x 44mm
Receptacle Mount (D)	-	-	-	Ø 16mm (BT-Z2E versions) Ø 18mm (BT-Z6E versions)
Max Material Thickness for Receptacle Mount	-	-	-	1.6mm (BT-Z2E versions) 2.5mm (BT-Z6E versions)
Foam** when using Lens Receptacle	-	-	-	Eriks CR Fest (neoprene based)
Foam Thickness	-	-	-	2mm (BT-Z2E versions) 4mm (BT-Z6E versions)
Weight of Individual Product	10.2gr	10.2gr (1x1 version) 18.4gr (1w1 version)	12.2gr	12.3gr (BT-Z2E versions) 13.5gr (BT-Z6E versions)
Packaging	2 or 10 pcs per box			
Box Weight (volume pack, 50 pcs)	1.39kg	1.39kg (1x1 version) 1.8kg (1w1 version)	1.49kg	1.85kg (BT-Z2E versions) 1.91kg (BT-Z6E versions)

*Avoid overlapping detection zones for the motion sensor. Heaters, fans, printers and copiers located in the detection zone may cause incorrect occupancy detections. Avoid direct light into the photocell detector.

** IP20: foam is intended to press-fit the receptacle and avoid rattle and rotation of the unit. It is the responsibility of the luminaire manufacturer to check the foam thickness for optimum performance.

IP66: foam is intended to press-fit the receptacle and provide an IP66 tight connection. It is the responsibility of the luminaire manufacturer to check the foam thickness for optimum performance.

BT-L2E1

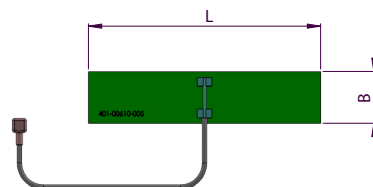
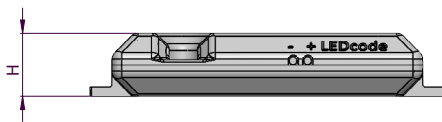
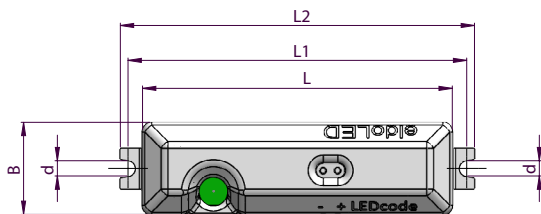

L	48
B	10.7
H	3.8
Wire length	254

Indicated dimensions are in mm
Adhesive tape already on antenna

BT-L1E-1x1 / 1w1

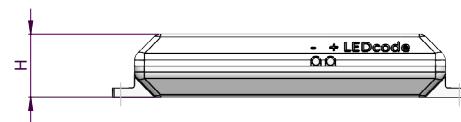
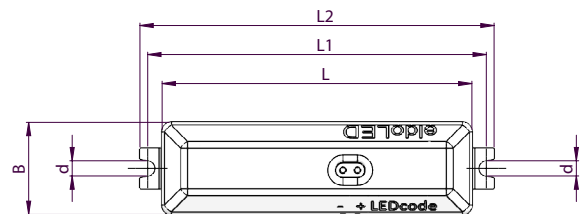

L	64
L1	70
L2	73.2
d	3.15
H	13
B	19

Indicated dimensions are in mm

BT Family Wireless Control – Datasheet

Mechanical Details (continued)

BT-S1E1

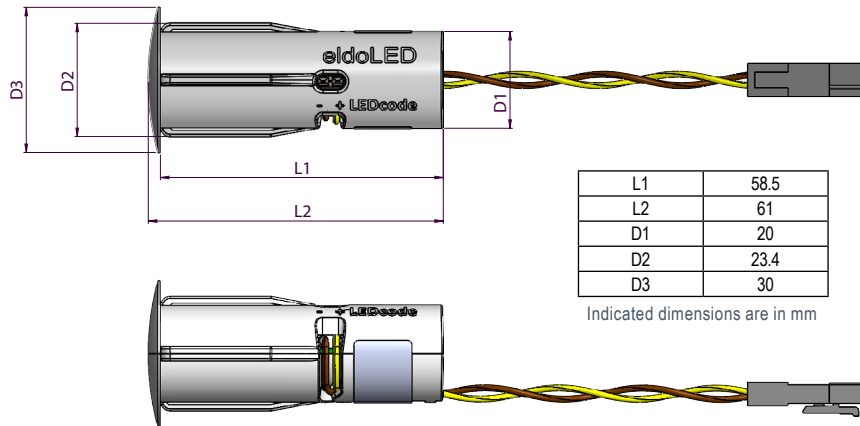

BT-Z2E

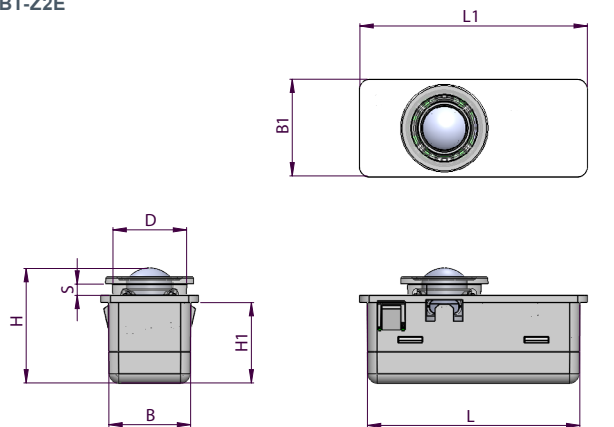

BT-Z6E

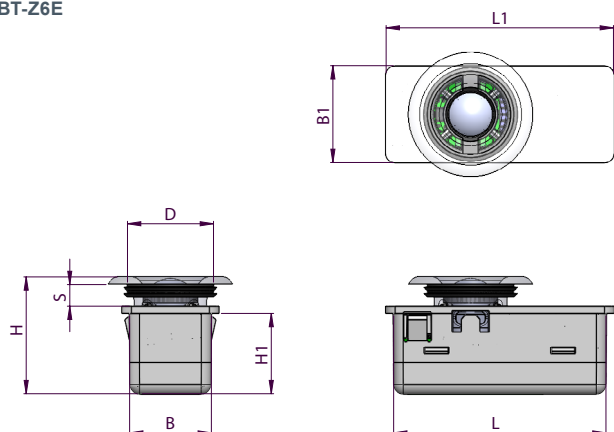

	BT-Z2E	BT-Z6E
L	43.9	
L1	47	
B	16.9	
B1	20	
D	15.2	17.8
H	23.6	21.4
H1	16.6	
S	2.3	4.45

Indicated dimensions in mm

BT Family Wireless Control – Datasheet

Mechanical Mounting Options

BT-Z2E-3x1, BT-Z2E-6x1
BT-Z6E-3x1, BT-Z6E-6x1

Round cut-out

Mounting instructions: see separate document on the product page on the eldoLED website:

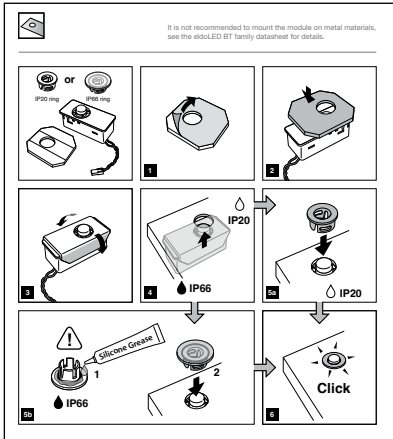

In case BT-Z6E modules are mounted onto a curved surface, please take the following into account:

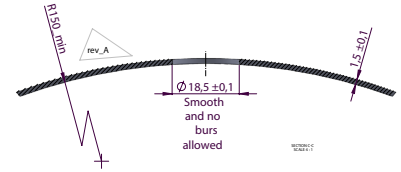
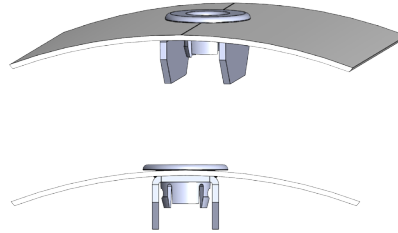

Rectangular cut-out

Mounting instructions: see separate document on the product page on the eldoLED website:

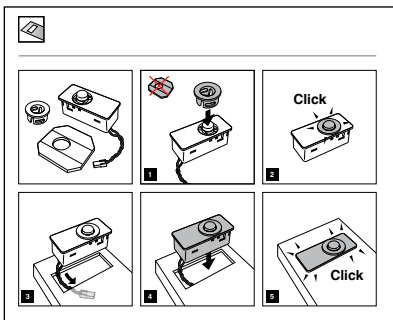



Sensor Characterization

3m ceiling height version

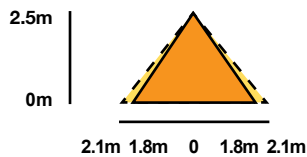
Sensitivity diagram for 360° presence detectors for BT-Z2E-3x1 and BT Z6E-3x1 versions





- Range for sideway passage (tangential motion) 
- Range for moving towards sensor (radial motion) 
- Range for sitting desk work (presence area) 

6m ceiling height version

Sensitivity diagram for 360° presence detectors for BT-Z2E-6x1 and BT Z6E-6x1 versions

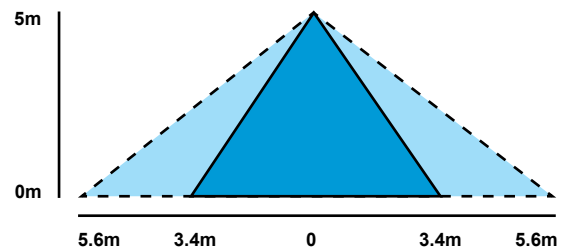
When 6m PIR is mounted at 2.5m, the numbers scale.
6m PIR has not been designed for desk work.



- Range for sideway passage (tangential motion) 
- Range for moving towards sensor (radial motion) 

BT Family Wireless Control – Datasheet

Self Test Sensor Module

After a power cycle the sensor module performs a self-test. A white LED flashes in a certain pattern during the self test. More information is available with your eldoLED sales representative.

Standards and Compliances

Radio Equipment Directive (RED) - Europe	2014/53/EU Note that RED covers EN 61347, EN 61547, EN 62311, EN 62493
ENEC Safety	EN 62368-1:2014 EN 62479:2010
UL Management Equipment, Energy Component	UL 916
Radiated Emissions	EN 55015 47 CFR part 15.247 RSS-210 issue 9 August 2016 RSS-247 issue 1 May 2015
EMC Compatibility (art 3.1)	EN301 489-1 v2.2.3 EN301 489-17 v3.2.4 EN55032-2015+A11:2020 EN55035:2017+A11:2020
Radio Spectrum (art 3.2)	EN300 328 v2.2.2
Bluetooth	Bluetooth Qualification & Declaration ID: D037520
Surge Immunity	ANSI C63.4:2014
Glow Wire Test	Passes 650°C glow wire test / 850°C glow wire test (France)
Restriction of Hazardous Substance	RoHS3 (Directives 2011/65/EU-2015/863/EU)
SVHC-list Substances	REACH Art 33

Safety



Risk of electrical shock. May result in serious injury or death. Disconnect power before servicing or installing.



The LED driver may only be connected and installed by a qualified electrician. All applicable regulations, legislation, and building codes must be observed. Incorrect installation of the LED driver can cause irreparable damage to the LED driver and the connected LEDs.



eldoLED products are designed to meet the performance specifications as outlined at certain operating conditions in the data sheet. It is the responsibility of the fixture manufacturer to test and validate the design and operation of the system under expected and potential use cases, including faults.



Please observe voltage drop over long cable lengths. Longer cable lengths increase EMI susceptibility.



Product renderings and dimensional drawings are generic for the housing type. Product label, connector type and quantity may vary.

Warranty

eldoLED Products are covered by a 5-year limited warranty. This is the only warranty provided and no other statements in this datasheet create any warranty of any kind. All other express and implied warranties are disclaimed. Complete warranty terms can be found at: www.eldoled.com/legal/terms-and-conditions

Note: Actual performance may differ as a result of end-user environment and application. The product images shown are for illustration purposes only and may not be an exact representation of the product. Specifications subject to change without notice.