

180/D-FF

180/D-FR

184/D-FF

184/D-FR

## AUFSTECKFASSUNG FÜR T9-T10 LEUCHSTOFFRÖHREN, MIT "INSTANT START" PUSH-ON LAMPHOLDERS FOR T9-T10 CIRCULAR FLUORESCENT LAMPS

### Technische Daten

#### Technical data

- Lampensockel - Lamp Cap	G10q
- Nennstrom und Nennspannung - Rated current and voltage	2A-250V
- Maximale Betriebstemperatur (IEC) - Maximum operating temperature (IEC)	T110
- Schutzgrad - Protection index	IP20
- Überspannungskategorie - Impulse withstand category	II

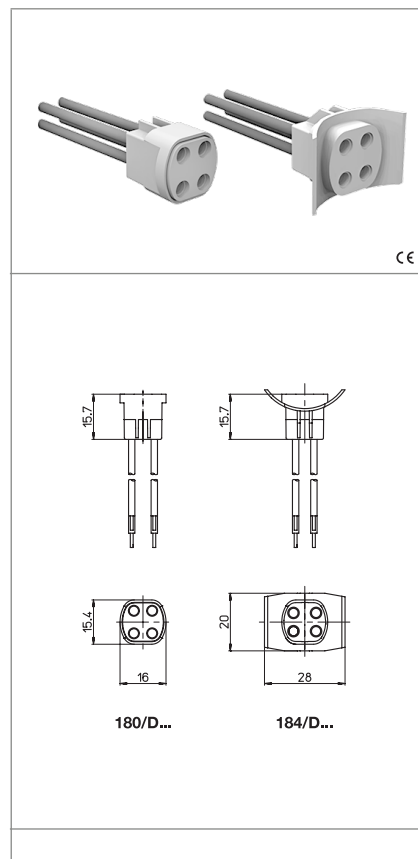







### Merkmale

#### Characteristics

FR= Starrer Leiter FF= Flexible (mehradrige) Leitung  
FR= Rigid conductor FF= Flexible conductor

– Gehäuse aus polycarbonat, weiß  
– White polycarbonate body

– Messingkontakte  
– Brass contacts

 Durchsteckbefestigung push fixing on the lamp	 an leitung gecrimpter Kontakt conductor crimped to the contact	 Flexibler Leitungsquerschnitt flexible conductor section	 Feste Leitungsabschnitte rigid conductor section
 Starre und flexible Leitungslänge rigid and flexible wires length	 62/... x5		

### Prüfzeichen

#### Quality marks



### Europäische Richtlinien

#### European directives

Gemäß "RoHS"  
"RoHS" compliant

Unterliegt nicht "WEEE"  
Not subject to "WEEE"

### Gewichte und Verpackung

#### Weights and packaging

Art. Codice prodotti Product references	g Peso netto Net weight	n° pz per sacco per bag	n° pz per scatola per box	n° pz per cartone per carton
180/D-FF	14,1		200	
180/D-FR	13,8		200	
184/D-FF	14,6		200	
184/D-FR	14,3		200	

### Bemerkung

#### Notes