

### 3345/FAU-13-TR

### 3345/MAU-13-TR

### 3345-C/FAU-13-TR

### 3345-C/MAU-13-TR

## PORTALAMPADE A PASTIGLIA PER LAMPADE FLUORESCENTI LINEARI T8-T12 ROUND LAMPHOLDERS FOR T8-T12 FLUORESCENT LINEAR LAMPS

### Dati tecnici

#### Technical data





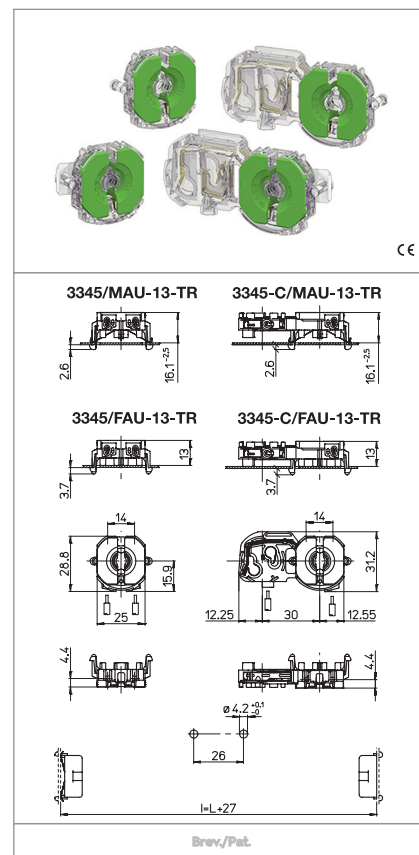

- Attacco lampada - Lamp cap	<b>G13</b>
- Corrente e tensione nominale - Rated current and voltage	<b>2A-500V</b>
- Temperatura massima di funzionamento (IEC) - Maximum operating temperature (IEC)	<b>T140 Tm110</b>
- Grado di protezione - Protection index	<b>IP20</b>
- Categoria di sovratensione - Impulse withstand category	<b>II</b>

### Caratteristiche

#### Characteristics

- Corpo in policarbonato trasparente  
- Transparent polycarbonate body
- Contatti in lega di rame  
- Copper alloy contacts
- Con top test  
- With top test

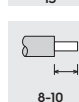

 fissaggio ad innesto posteriore, fisso back mounting, fixed	 fissaggio ad innesto posteriore, mobile back mounting, adjustable	 spessore lamiera di fissaggio fixing metal plate thickness 0,6-1,2	 spessore thickness 13
 rotore in PBT verde con scatti di... PBT green rotor with position of...	 serrafilo automatico a 2 fori push-wire terminals with 2 holes	 sezione conduttore rigido rigid conductor section 0,5-1	 spelatura cavetti rigidi rigid wires stripping 8-10

### Marchi di qualità

#### Quality marks

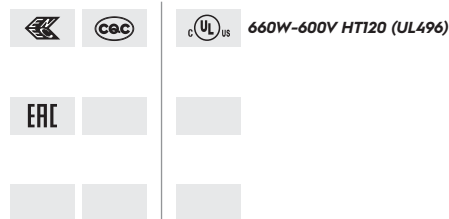

### Direttive Europee

#### European directives

Conforme "RoHS"  
"RoHS" compliant  
Non soggetto alla "RAEE"  
Not subject to "WEEE"

### Pesi e confezioni

#### Weights and packaging

Art. Codice prodotti Product references	g Peso netto Net weight	n° pz per sacco per bag	n° pz per scatola per box	n° pz per cartone per carton
3345/FAU-13-TR	4,3	1000		
3345/MAU-13-TR	4,9	1000		
3345-C/FAU-13-TR	7	500		
3345-C/MAU-13-TR	7,6	1000		

### Note

#### Notes