

770/38

GESCHÜTZTE LAMPENFASSUNG T8 FÜR LINEARE LEUCHTSTOFFLAMPEN + SCHUTZROHR PROTECTED LAMPHOLDER FOR T8 + COVER TUBE, T12 FLUORESCENT LINEAR LAMPS

Technische Daten

Technical data

- LAMPENSOCKEL - Lamp cap	G13
- Nennstrom und Nennspannung - Rated current and voltage	2A-250V
- Maximale Betriebstemperatur (IEC) - Maximum operating temperature (IEC)	T130 Tm110
- Schutzgrad - Protection index	IP66/67
- Überspannungskategorie - Impulse withstand category	III

Merkmale

Characteristics

- Gehäuse aus PBT, in transparent und weiss
- White polycarbonate and white PBT body
- Kupferlegierte Kontakte
- Copper alloy contacts
- Neopren// Silikon Dichtung
- Neoprene/silicone gaskets

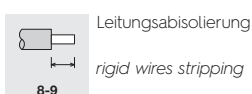
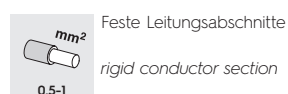
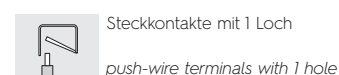
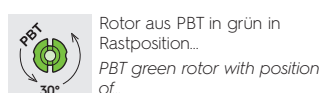
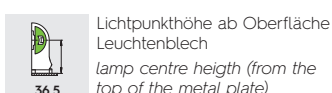
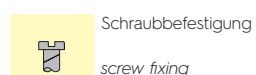
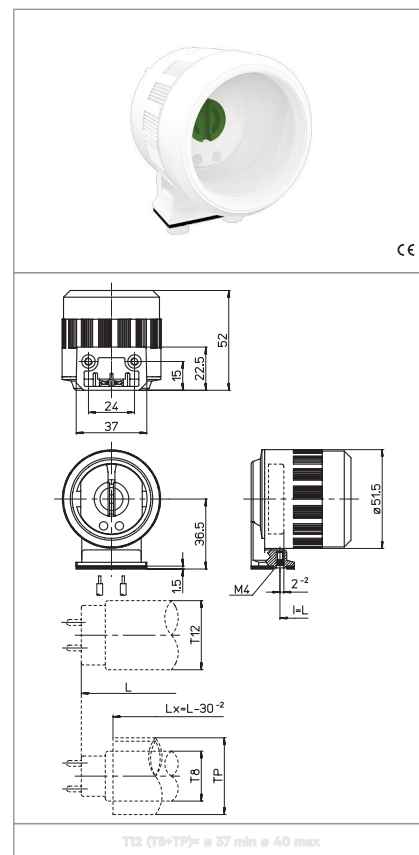

Prüfzeichen Quality marks

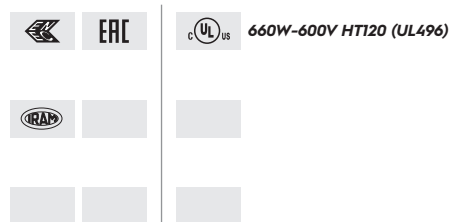

Europäische Richtlinien European directives

gemäß "RoHS"
"RoHS" compliant
unterliegt nicht "WEEE"
Not subject to "WEEE"

Gewichte und Verpackung Weights and packaging

Artikel/Art. Produktinweise Product references	g Nettogewicht Net weight	n° pz pro Beutel per bag	n° pz pro Box per box	n° pz pro Karton per carton
770/38	54,7		50	

Bemerkung

Notes