

16/V

STARTERFASSUNG STARTERHOLDERS

Technische Daten

Technical data





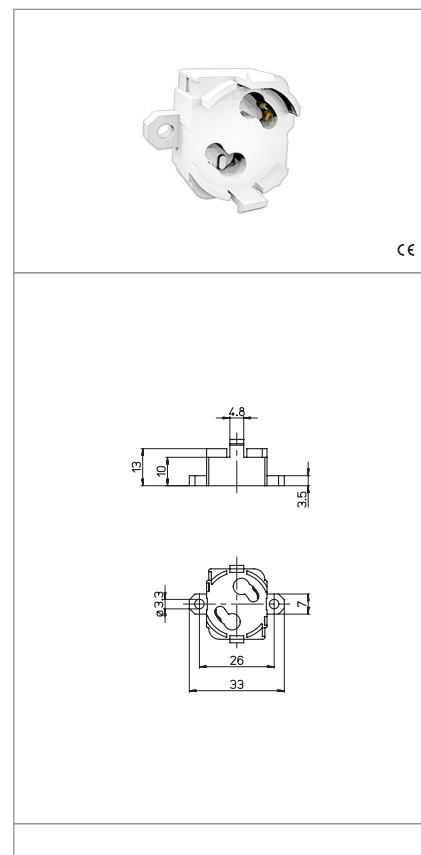

- Nennstrom und Nennspannung - Rated current and voltage	2A-250V
- Maximale Betriebstemperatur (IEC) - Maximum operating temperature (IEC)	T110
- Schutzgrad - Protection index	IP20
- Überspannungskategorie - Impulse withstand category	III

Merkmale

Characteristics

- Gehäuse aus polycarbonat, weiß
- White polycarbonate body
- Kupferlegierte Kontakte
- Copper alloy contacts



 Schraubbefestigung screw fixing	 Materialdicke thickness 10	 Steckkontakte mit 1 Loch push-wire terminals with 1 hole	 Feste Leitungsabschnitte rigid conductor section mm² 0,5-1
 Leitungsabsisolierung rigid wires stripping 8-9	 Befestigungslöcher gem IP40 IP40 in the hooking points IP40		

Prüfzeichen Quality marks



Europäische Richtlinien European directives

gemäß "RoHS"
"RoHS" compliant
unterliegt nicht "WEEE"
Not subject to "WEEE"

Gewichte und Verpackung Weights and packaging

Artikel/Art. Produktreihe Product references	g Nettogewicht Net weight	n° pz pro Beutel per bag	n° pz pro Box per box	n° pz pro Karton per carton
16/V	3,6	1000	500	

Bemerkung

Notes