

1226/Z-SF

LAMPENFASSUNG FÜR HALOGENHOCHVOLTlampEN

LAMPHOLDER FOR MAIN VOLTAGE TUNGSTEN HALOGEN INCANDESCENT LAMPs

Technische Daten

Technical data

- LAMPENSOCKEL - Lamp cap	GU10 GZ10
- Nennstrom und Nennspannung - Rated current and voltage	2A-250V
- Maximale Betriebstemperatur (IEC) - Maximum operating temperature (IEC)	T270
- Schutzgrad - Protection index	IP20
- Überspannungskategorie - Impulse withstand category	II





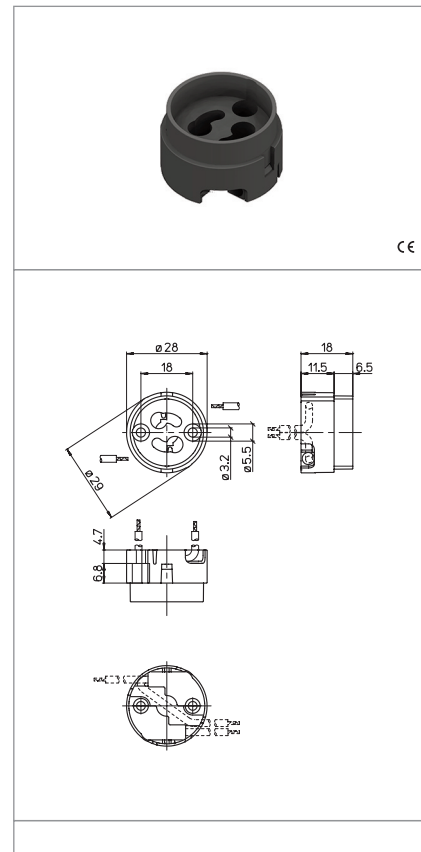

Merkmale

Characteristics

- Gehäuse aus LCP, schwarz
– Black LCP body
- Nickelbeschichtete Kontakte aus Stahl
– Nickel plated steel contacts

Die Befestigungsschrauben müssen mit einem max. Drehmoment von 0,3Nm angezogen werden
The fixing screws must be screwed by max. torque of 0,3Nm



 Schraubbefestigung screw fixing	 Steckkontakte mit 1 Loch push-wire terminals with 1 hole	 mm ² 0,5-1 Feste Leitungsabschnitte rigid conductor section	 Leitungsabsicherung 7-8 rigid wires stripping
 Schutzklasse II class II insulated	 118/...		

Prüfzeichen

Quality marks



Europäische Richtlinien

European directives

gemäß "RoHS"
"RoHS" compliant
unterliegt nicht "WEEE"
Not subject to "WEEE"

Gewichte und Verpackung

Weights and packaging

Artikel/Art. Produktinweise Product references	g Nettogewicht Net weight	n° pz pro Beutel per bag	n° pz pro Box per box	n° pz pro Karton per carton
1226/Z-SF	6,7		200	

Bemerkung

Notes