

289/21-TR
289/N-21-TR

289/25-TR
289/N-25-TR

289/30-TR
289/N-30-TR

289/36-TR
289/N-36-TR

DURCHSTECKFASSUNG FÜR T5 LEUCHTSTOFFRÖHREN
TOMBSTONE LAMP HOLDERS FOR T5 FLUORESCENT LINEAR LAMPS

Technische Daten

Technical data





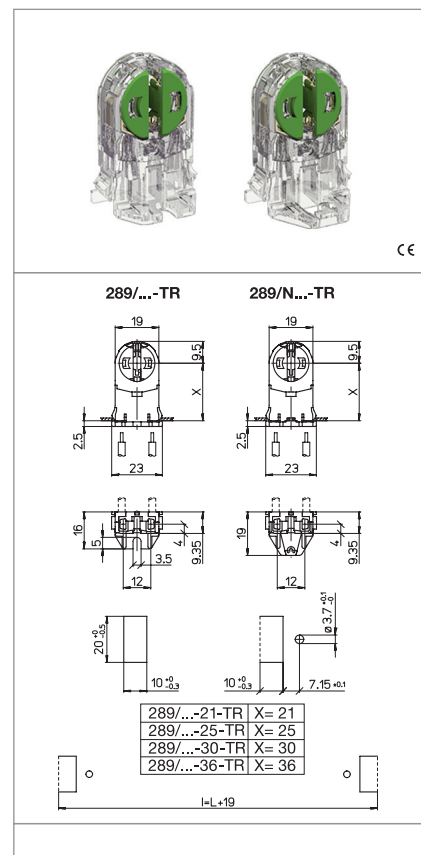

- Lampensockel - Lamp cap	G5
- Nennstrom und Nennspannung - Rated current and voltage	2A-500V
- Maximale Betriebstemperatur (IEC) - Maximum operating temperature (IEC)	T130 Tm110
- Schutzgrad - Protection index	IP20
- Überspannungskategorie - Impulse withstand category	III

Merkmale

Characteristics

- Gehäuse aus polycarbonat, transparent
- Transparent polycarbonate body
- Kupferlegierte Kontakte
- Copper alloy contacts
- Mit Top Test
- With top test



 <p>Durchsteckbefestigung push-through fixing</p>	 <p>Blechstärke zur Befestigung fixing metal plate thickness 0,4-2</p>	 <p>Lichtpunkthöhe ab Unterseite leuchtenblech lamp centre height (from the bottom of the metal plate) x</p>	<p>N Ausführung mit Haltezapfen version with stop nib</p>
 <p>Rotor aus PBT in grün in Rastposition... PBT green rotor with position of... 90°</p>	 <p>Steckkontakte mit 2 Löchern push-wire terminals with 2 holes</p>	 <p>Feste Leitungsabschnitte rigid conductor section 0,5-1 mm²</p>	 <p>Leitungsabsicherung rigid wires stripping 8-9</p>

Prüfzeichen
Quality marks

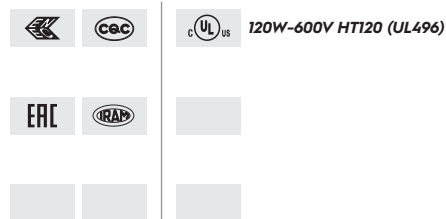

Europäische Richtlinien
European directives

gemäß "RoHS"
"RoHS" compliant
unterliegt nicht "WEEE"
Not subject to "WEEE"

Gewichte und Verpackung
Weights and packaging

Artikel/Art. Produktinweise Product references	g Nettogewicht Net weight	n° pz pro Beutel per bag	n° pz pro Box per box	n° pz pro Karton per carton
289/21-TR	3,9	1000		
289/25-TR	4	1000		
289/30-TR	4,4	1000		
289/36-TR	4,8	1000		
289/N-21-TR	3,9	1000		
289/N-25-TR	4	1000		
289/N-30-TR	4,3	1000		
289/N-36-TR	4,7	1000		

Bemerkung

Notes