

203-21/SG-150

LAMPENFASSUNG FÜR METALLDAMPFLAMPEN (ENTLADUNGSLAMPEN) LAMPHOLDER FOR HALIDE VAPOUR DISCHARGE LAMPS

Technische Daten

Technical data





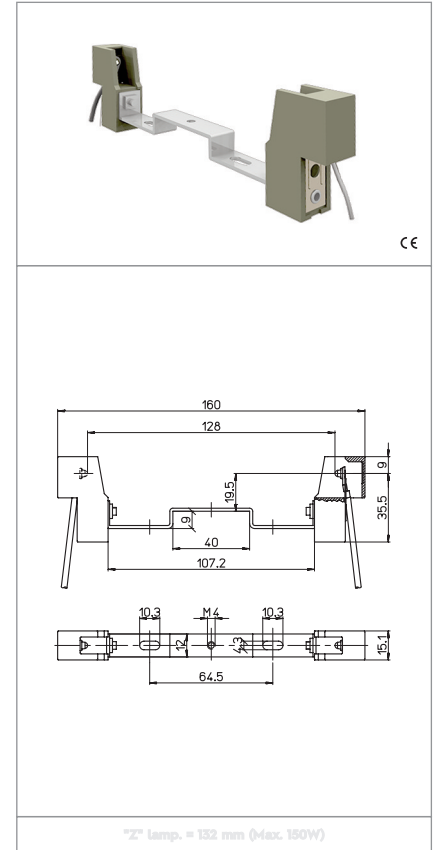

- LAMPENSOCKEL - Lamp cap	RX7s-24
- Nennstrom und Nennspannung - Rated current and voltage	4A-1000V
- Maximale Betriebstemperatur (IEC) - Maximum operating temperature (IEC)	T250
- Überspannungskategorie - Impulse withstand category	II

Merkmale

Characteristics

- Bugel gemäß Klasse II (250V) isoliert
- Zinc plated steel class II insulated support (250V)



 Schraubbefestigung screw fixing	 an leitung gecrimpter Kontakt conductor crimped to the contact	 Bereich mehrdrige Leitungen mit Aderendhülsen section of the flexible conductor with ferrule SIL 0,75	 Leitungslänge flexibel flexible wire length 25 cm
 geeignet für eine Zündspannung von... suitable for impulse ignition voltage up to... 5kV	 S-204/1	 S-204/112	

Prüfzeichen

Quality marks



Europäische Richtlinien

European directives

gemäß "RoHS"
"RoHS" compliant
unterliegt nicht "WEEE"
Not subject to "WEEE"

Gewichte und Verpackung

Weights and packaging

Artikel/Art. Produktinweise Product references	g Nettogewicht Net weight	n° pz pro Beutel per bag	n° pz pro Box per box	n° pz pro Karton per carton
203-21/SG-150	77,5		20	

Bemerkung

Notes

Bemerkung

Note

ARTIKEL AUS STEATIT

Produkte, die aus Steatit formgespritzt sind, durchlaufen dimensionale Veränderungen bei durch Austrocknung bei hohen Temperaturen. Daher ist ein Hinweis auf die in DIN40680 angegebenen Toleranzen anzugeben, Mittelwert bezogen auf die Nennwerte gemäß Angabe im Katalog.

ARTICLES IN STEATITE

Products moulded in steatite undergo dimensional changes during the high temperature curing process. Therefore reference must be made to the tolerance stated in DIN 40680, middle values referred to the nominal values stated in the catalogue.

ABMESSUNGEN DIMENSIONS	Toleranzen/Tolerance
	DIN40680
Fino a/Up to 4	±0,15
Von/From 4,1 bis/to 6	±0,20
Von/From 6,1 bis/to 8	±0,25
Von/From 8,1 bis/to 10	±0,30
Von/From 10,1 bis/to 13	±0,35
Von/From 13,1 bis/to 16	±0,40
Von/From 16,1 bis/to 20	±0,45
Von/From 20,1 bis/to 25	±0,50
Von/From 25,1 bis/to 30	±0,55
Von/From 30,1 bis/to 35	±0,60
Von/From 35,1 bis/to 40	±0,65
Von/From 40,1 bis/to 45	±0,70
Von/From 45,1 bis/to 50	±0,80
Von/From 50,1 bis/to 55	±0,90
Von/From 55,1 bis/to 60	±1,00