

441/V/16

**LAMPENFASSUNG MIT STARTERFASSUNG FÜR KOMPAKTSTOFFLAMPEN (TC-F)**  
**LAMPHOLDER WITH STARTERHOLDER FOR COMPACT FLUORESCENT LAMPS (TC-F)**

**Technische Daten**

Technical data

- LAMPENSOCKEL - Lamp cap	2G11
- Nennstrom und Nennspannung - Rated current and voltage	2A-250V
- Maximale Betriebstemperatur (IEC) - Maximum operating temperature (IEC)	T140
- Schutzgrad - Protection index	IP20
- Überspannungskategorie - Impulse withstand category	III







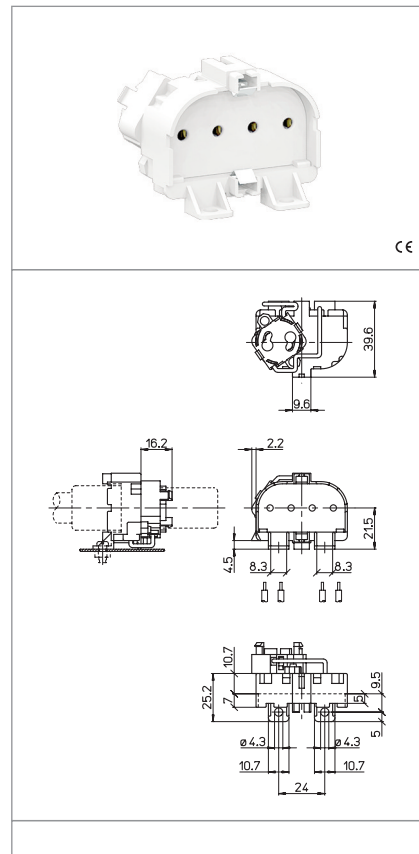

**Merkmale**

Characteristics

mit rückseitiger Starterfassung  
with 16/V back starterholder

- Gehäuse aus PBT, weiss  
- White PBT body
- Kupferlegierte Kontakte  
- Copper alloy contacts



 Schraubbefestigung screw fixing	 Lichtpunkthöhe ab Oberfläche Leuchtenblech lamp centre height (from the top of the metal plate)	 Steckkontakte mit 2 Löchern push-wire terminals with 2 holes	 mm <sup>2</sup> Feste Leitungsabschnitte rigid conductor section
 Leitungsabsolierung rigid wires stripping	 132 1132	 1128	 120

**Prüfzeichen**  
Quality marks

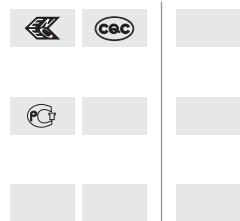

**Europäische Richtlinien**  
European directives

gemäß "RoHS"  
"RoHS" compliant  
unterliegt nicht "WEEE"  
Not subject to "WEEE"

**Gewichte und Verpackung**  
Weights and packaging

Artikel/Art. Produktinweise Product references	g Nettogewicht Net weight	n° pz pro Beutel per bag	n° pz pro Box per box	n° pz pro Karton per carton
441/V/16	21,2		100	

**Bemerkung**

Notes