

3254-12/S-TR

3254-12/S-SN-TR

3254-12/C-TR

3254-12/C-SN-TR

**DURCHSTECKFASSUNG FÜR T8-T12 LEUCHTSTOFFRÖHREN**  
**TOMBSTONE LAMP HOLDERS FOR T8-T12 FLUORESCENT LINEAR LAMPS**

**Technische Daten**

Technical data







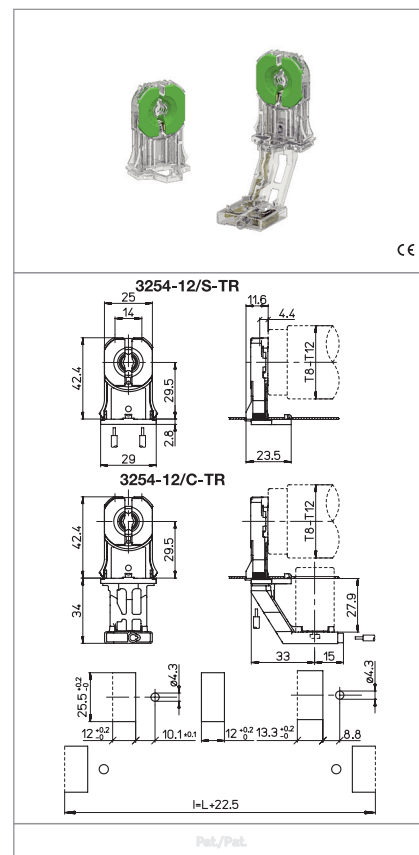

- Lampensockel - Lamp cap	<b>G13</b>
- Nennstrom und Nennspannung - Rated current and voltage	<b>2A-500V 2A-250V (.../C-...)</b>
- Maximale Betriebstemperatur (IEC) - Maximum operating temperature (IEC)	<b>T140 Tm110</b>
- Schutzgrad - Protection index	<b>IP20</b>
- Überspannungskategorie - Impulse withstand category	<b>II</b>

**Merkmale**

Characteristics

- Gehäuse aus polycarbonat, transparent  
- Transparent polycarbonate body
- Kupferlegierte Kontakte  
- Copper alloy contacts
- Mit Top Test  
- With top test



 Durchsteckbefestigung push-through fixing	 Blechstärke zur Befestigung fixing metal plate thickness 0,4-2	 Lichtpunkthöhe ab Unterseite leuchtenblech lamp centre height (from the bottom of the metal plate) 29,5	 Ausführung ohne Haltezapfen version without stop nib
 Rotor aus PBT in Rastposition... PBT rotor with position of... 90°	 Steckkontakte mit 2 Löchern push-wire terminals with 2 holes	 Feste Leitungsabschnitte rigid conductor section 0,5-1	 Leitungsabsicherung rigid wires stripping 8-10

**Prüfzeichen**  
Quality marks

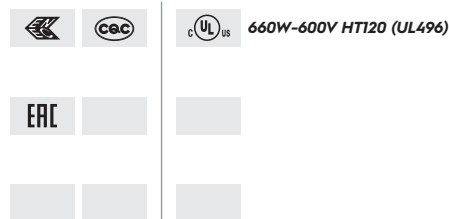

**Europäische Richtlinien**  
European directives

gemäß "RoHS"  
"RoHS" compliant  
unterliegt nicht "WEEE"  
Not subject to "WEEE"

**Gewichte und Verpackung**  
Weights and packaging

Artikel/Art. Produktinweise Product references	g Nettogewicht Net weight	n° pz pro Beutel per bag	n° pz pro Box per box	n° pz pro Karton per carton
3254-12/S-TR	6,3	500		
3254-12/S-SN-TR	6,3	500		
3254-12/C-TR	11,2	250		
3254-12/C-SN-TR	11,2	250		

**Bemerkung**

Notes