

1783/38

GESCHÜTZTE LAMPENFASSUNG T8 FÜR LINEARE LEUCHTSTOFFLAMPEN + SCHUTZROHR
PROTECTED LAMPHOLDER FOR T8 + COVER TUBE, T12 FLUORESCENT LINEAR LAMPS

Technische Daten

Technical data







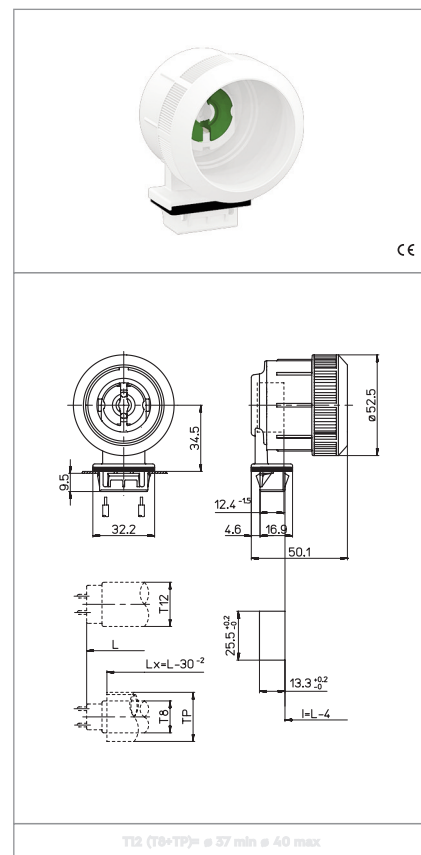

- LAMPENSOCKEL - Lamp cap	G13
- Nennstrom und Nennspannung - Rated current and voltage	2A-500V
- Maximale Betriebstemperatur (IEC) - Maximum operating temperature (IEC)	T140 Tm110
- Schutzgrad - Protection index	IP66/67
- Überspannungskategorie - Impulse withstand category	II

Merkmale

Characteristics

- Gehäuse aus PBT, in transparent und weiss
- White polycarbonate and white PBT body
- Kupferlegierte Kontakte
- Copper alloy contacts
- Neopren// Silikon Dichtung
- Neoprene/silicone gaskets



 Rastbefestigung snap-in fixing	 Blechstärke zur Befestigung fixing metal plate thickness 0,8-2	 Lichtpunkthöhe ab Oberfläche Leuchtenblech lamp centre height (from the top of the metal plate) 34,5	 Rotor aus PBT in grün in Rastposition... PBT green rotor with position of... 90°
 Steckkontakte mit 1 Loch push-wire terminals with 1 hole	 Feste Leitungsabschnitte rigid conductor section 0,5-1	 Leitungsabsolierung rigid wires stripping 10-11	 IP66 IP67 IP66/67 geschützt IP66/67 protected

Prüfzeichen
Quality marks

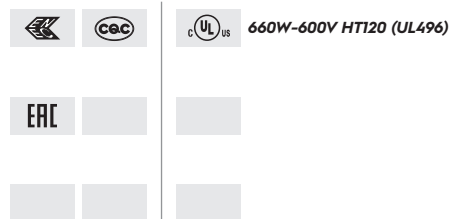

Europäische Richtlinien
European directives

gemäß "RoHS"
"RoHS" compliant
unterliegt nicht "WEEE"
Not subject to "WEEE"

Gewichte und Verpackung
Weights and packaging

Artikel/Art. Produktinweise Product references	g Nettogewicht Net weight	n° pz pro Beutel per bag	n° pz pro Box per box	n° pz pro Karton per carton
1783/38	43,2		50	

Bemerkung

Notes