

1305/SF

LAMPENFASSUNG FÜR METALLDAMPFLAMPEN (ENTLADUNGSLAMPEN) LAMPHOLDER FOR HALIDE VAPOUR DISCHARGE LAMPS

Technische Daten

Technical data







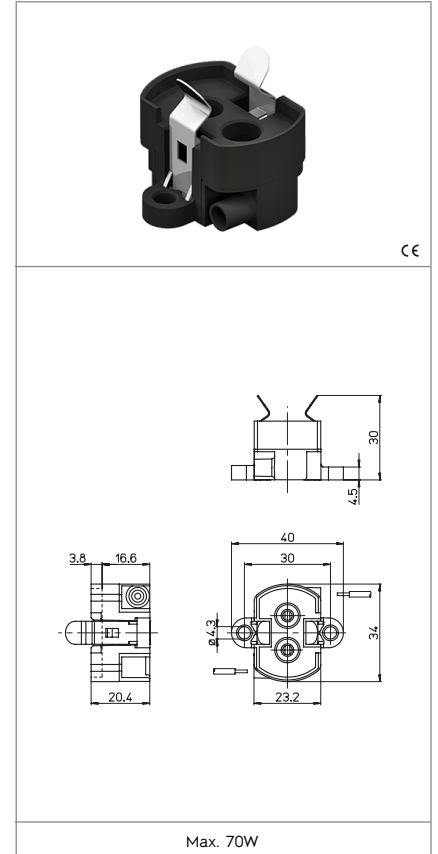

- Lampensockel - Lamp Cap	G12
- Nennstrom und Nennspannung - Rated current and voltage	2A-250V
- Maximale Betriebstemperatur (IEC) - Maximum operating temperature (IEC)	T250
- Schutzgrad - Protection index	IP20
- Überspannungskategorie - Impulse withstand category	III

Merkmale

Characteristics

- Gehäuse aus LCP, schwarz
– Black LCP body
- Nickelbeschichtete Kontakte aus Stahl
– Nickel plated steel contacts



 Schraubbefestigung screw fixing	 Steckkontakte mit 1 Loch push-wire terminals with 1 hole	 Durchmesser von flexiblen Leitungen mit Aderendhülse diameter of the flexible conductor with ferrule ø1,8 max	 Abisolierung flexible Leitungen flexible with ferrule wires stripping 10-11
 Feste Leitungsabschnitte rigid conductor section 0,5-1	 Leitungsabisolierung rigid wires stripping 8-9	 geeignet für eine Zündspannung von... suitable for impulse ignition voltage up to... 5kV	 Schutzklasse II class II insulated

Prüfzeichen Quality marks

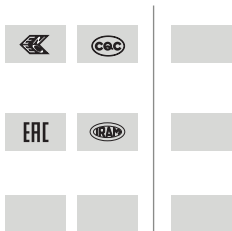

Europäische Richtlinien European directives

Gemäß "RoHS"
"RoHS" compliant

Unterliegt nicht "WEEE"
Not subject to "WEEE"

Gewichte und Verpackung Weights and packaging

Art. Codice prodotti Product references	g Peso netto Net weight	n° pz per sacco per bag	n° pz per scatola per box	n° pz per cartone per carton
1305/SF	11,9		200	

Bemerkung

Notes