

211-21/SB

LAMPENFASSUNG FÜR METALLDAMPFLAMPEN (ENTLADUNGSLAMPEN) LAMPHOLDER FOR HALIDE VAPOUR DISCHARGE LAMPS

Technische Daten

Technical data



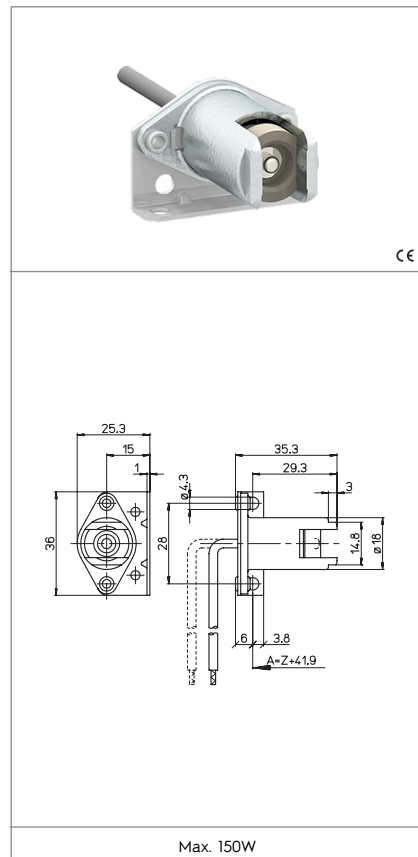

- Lampensockel - Lamp Cap	RX7s RX7s-24
- Nennstrom und Nennspannung - Rated current and voltage	4A-250V
- Maximale Betriebstemperatur (IEC) - Maximum operating temperature (IEC)	T250
- Schutzgrad - Protection index	IP20
- Überspannungskategorie - Impulse withstand category	III



Merkmale

Characteristics

- Aluminiumgehäuse
- Aluminium body
- Leitungsschutz PPS, schwarz (TI=240°C)
- Black PPS cable protection (TI= 240 °C)
- Nickel Kontakt
- Nickel contact

 Schraubbefestigung screw fixing	 an leitung punktgeschweisster Kontakt conductor electrically spot-welded to the contact	 Bereich mehradrige Leitungen mit Aderendhülsen section of the flexible conductor with ferrule	 Leitungslänge flexibel flexible wire length
 geeignet für eine Zündspannung von... suitable for impulse ignition voltage up to... 5kV			

Max. 150W

Prüfzeichen

Quality marks

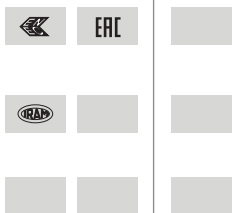

Europäische Richtlinien

European directives

Gemäß "RoHS"
"RoHS" compliant
Unterliegt nicht "WEEE"
Not subject to "WEEE"

Gewichte und Verpackung

Weights and packaging

Art. Codice prodotti Product references	g Peso netto Net weight	n° pz per sacco per bag	n° pz per scatola per box	n° pz per cartone per carton
211-21/SB	25,1		100	

Bemerkung

Notes