

1305

1305/DS

1305/DTT

LAMPENFASSUNG FÜR METALLDAMPFLAMPEN (ENTLADUNGSLAMPEN)
LAMPHOLDER FOR HALIDE VAPOUR DISCHARGE LAMPS

Technische Daten

Technical data



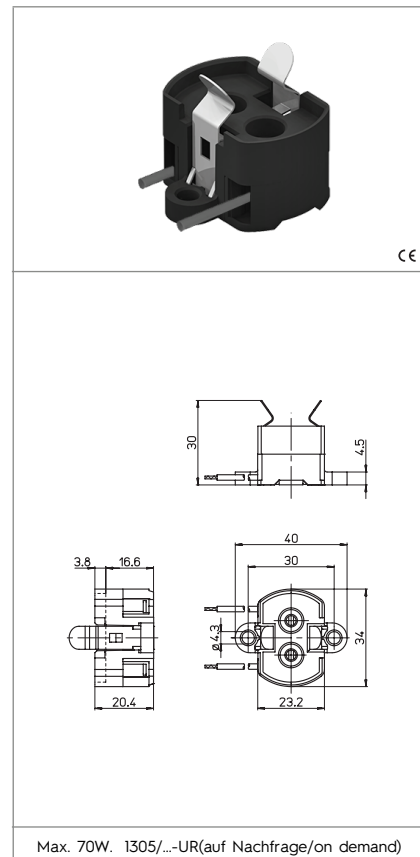



- Lampensockel - Lamp Cap	G12
- Nennstrom und Nennspannung - Rated current and voltage	2A-250V
- Maximale Betriebstemperatur (IEC) - Maximum operating temperature (IEC)	T250
- Schutzgrad - Protection index	IP20
- Überspannungskategorie - Impulse withstand category	III



Merkmale

Characteristics

- Gehäuse aus LCP, schwarz
- Black LCP body
- Nickel Kontakt
- Nickel contacts

 Schraubbefestigung <i>screw fixing</i>	 an leitung punktgeschweisster Kontakt <i>conductor electrically spot-welded to the contact</i>	 Bereich mehradrige Leitungen mit Aderendhülsen <i>section of the flexible conductor with ferrule</i> SIL 0,75	 Bereich mehradrige Leitungen mit Aderendhülsen <i>section of the flexible conductor with ferrule</i> mm ² DS 1
 Bereich mehradrige Leitungen mit Aderendhülsen <i>section of the flexible conductor with ferrule</i> DTT 0,75	 Leitungslänge flexibel <i>flexible wire length</i> 20 cm	 geeignet für eine Zündspannung von... <i>suitable for impulse ignition voltage up to...</i> 5kV	

Prüfzeichen

Quality marks



Europäische Richtlinien
European directives

Gemäß "RoHS"
"RoHS" compliant

Unterliegt nicht "WEEE"
Not subject to "WEEE"

Gewichte und Verpackung

Weights and packaging

Art. Codice prodotti <i>Product references</i>	g Peso netto <i>Net weight</i>	n° pz per sacco <i>per bag</i>	n° pz per scatola <i>per box</i>	n° pz per cartone <i>per carton</i>
1305	19,1		200	
1305/DS	22		200	
1305/DTT	17,6		200	

Bemerkung

Notes