

1306/SF-14

1306/SF-18-20

LAMPENFASSUNG FÜR METALLDAMPFLAMPEN (ENTLADUNGSLAMPEN)
LAMPHOLDER FOR HALIDE VAPOUR DISCHARGE LAMPS

Technische Daten

Technical data





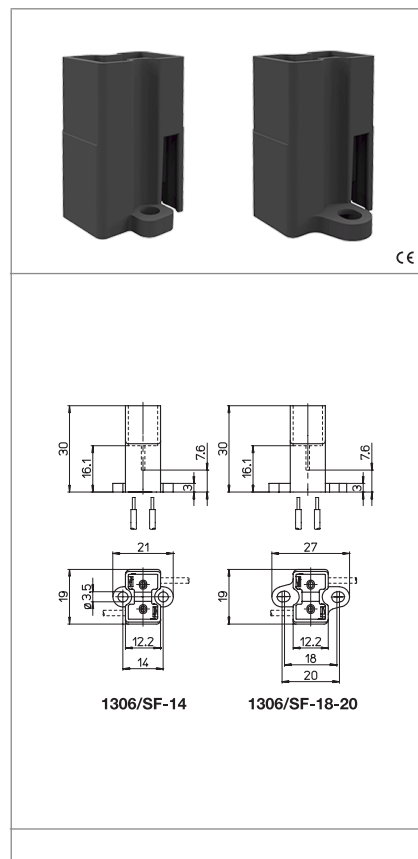

- Lampensockel - Lamp Cap	G8.5
- Nennstrom und Nennspannung - Rated current and voltage	2A-500V
- Maximale Betriebstemperatur (IEC) - Maximum operating temperature (IEC)	T270
- Schutzgrad - Protection index	IP20
- Überspannungskategorie - Impulse withstand category	III

Merkmale

Characteristics

- Gehäuse aus LCP, schwarz
- Black LCP body
- Silberbeschichtete Kontakte aus CuNiZn
- Silver plated CuNiZn (German silver) contacts



 Schraubbefestigung <i>screw fixing</i>	 Steckkontakte mit 1 Loch <i>push-wire terminals with 1 hole</i>	 Durchmesser von flexiblen Leitungen mit Aderendhülse <i>diameter of the flexible conductor with ferrule</i>	 Feste Leitungsabschnitte <i>rigid conductor section</i>
 Isolierung starre und flexible Leitungen mit Aderendhülse <i>rigid and flexible with ferrule wires stripping</i>	 geeignet für eine Zündspannung von... <i>suitable for impulse ignition voltage up to...</i>		

Prüfzeichen
Quality marks

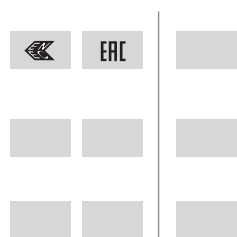

Europäische Richtlinien
European directives

Gemäß "RoHS"
"RoHS" compliant

Unterliegt nicht "WEEE"
Not subject to "WEEE"

Gewichte und Verpackung
Weights and packaging

Art. Codice prodotti Product references	g Peso netto Net weight	n° pz per sacco per bag	n° pz per scatola per box	n° pz per cartone per carton
1306/SF-14	5,4		500	
1306/SF-18-20	5		500	

Bemerkung

Notes