

111

111/AU

STARTERFASSUNG STARTERHOLDER

Technische Daten Technical data







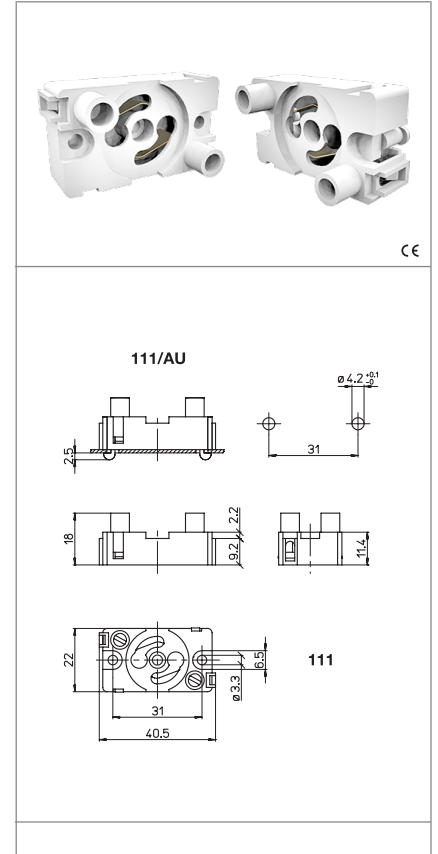

- Nennstrom und Nennspannung - Rated current and voltage	2A-250V
- Maximale Betriebstemperatur (IEC) - Maximum operating temperature (IEC)	
- Schutzgrad - Protection index	IP20
- Überspannungskategorie - Impulse withstand category	III

Merkmale

Characteristics

- Gehäuse aus polycarbonat, weiß
- White polycarbonate body
- Messingkontakte
- Brass contacts



 Schraubbefestigung screw fixing	 Einteckbefestigung push-in fixing	 Blechstärke zur Befestigung fixing metal plate thickness	 Materialdicke thickness
 Schraubklemmen screw terminals	 Flexibler Leitungsquerschnitt flexible conductor section	 Feste Leitungsabschnitte rigid conductor section	 Isolierung starre und flexible Leitungen rigid and flexible wires stripping

Prüfzeichen Quality marks

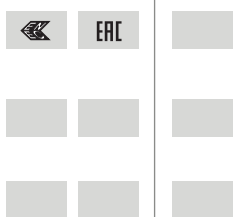

Europäische Richtlinien European directives

Gemäß "RoHS"
"RoHS" compliant
Unterliegt nicht "WEEE"
Not subject to "WEEE"

Gewichte und Verpackung Weights and packaging

Art. Codice prodotti Product references	g Peso netto Net weight	n° pz per sacco per bag	n° pz per scatola per box	n° pz per cartone per carton
111	7	1000		
111/AU	7		200	

Bemerkung

Notes