

130/V

130/A

CLIPS
CLIPS

Technische Daten



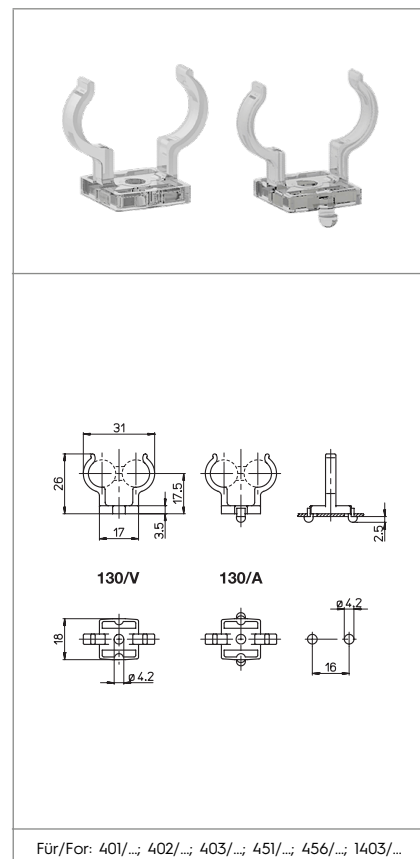









Technical data



Merkmale

Characteristics

aus polycarbonat, transparent
in transparent polycarbonate

 130/V	Schraubbefestigung screw fixing	 130/A	Eintieckbefestigung push-in fixing	 0,6-1	Blechstärke zur Befestigung fixing metal plate thickness	 17,5	Lichtpunkthöhe lamp centre height (from the top of the metal plate)
							
							

Prüfzeichen
Quality marks

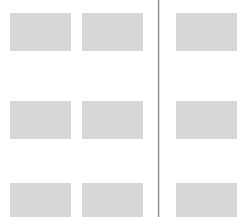

Europäische Richtlinien
European directives

Gemäß "RoHS"
"RoHS" compliant
Unterliegt nicht "WEEE"
Not subject to "WEEE"

Gewichte und Verpackung
Weights and packaging

Art. Codice prodotti Product references	g Peso netto Net weight	n° pz per sacco per bag	n° pz per scatola per box	n° pz per cartone per carton
130/V	1,3	1000	200	
130/A	1,4	1000	200	

Bemerkung

Notes

130/V 130/A

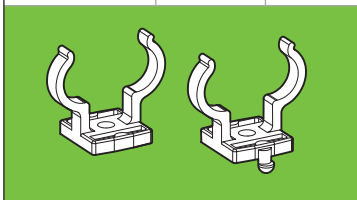

GANCI
in policarbonato trasparente stabilizzato agli UV

CLIPS
in UV resistant transparent polycarbonate

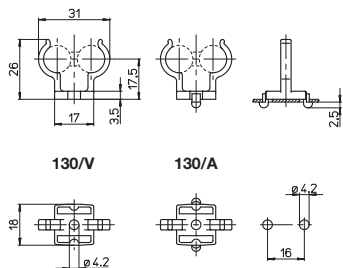

Per/For: 406/...

133/V 133/A

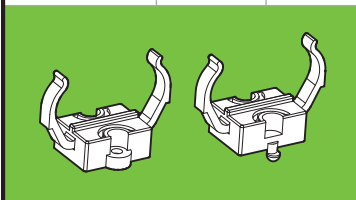

GANCI
in policarbonato trasparente stabilizzato agli UV

CLIPS
in UV resistant transparent polycarbonate

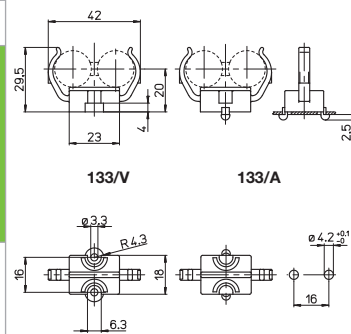

Per/For: 431/...

