

SCHEDA TECNICA PRODOTTO DATASHEET

ARTICOLO: SKY SYSTEM S-C

CODICE: 1003K

Caratteristiche meccaniche/Mechanical features:

Corpo/Body:	Alluminio estruso/Extruded aluminum
Colore/Colour:	RAL 9004
Dissipatore/Heatsink:	Lamiera di alluminio/Aluminum sheet
Diffusore / Diffuser	Polycarbonato trasparente + film microstrutturato UGR<19 - Fush joint transparent polycarbonate + microstructured film UGR<19
Viteria/Screws:	Acciaio/Steel
Dissipazione/Dissipation:	Statica/Static
Peso/Weight:	2Kg

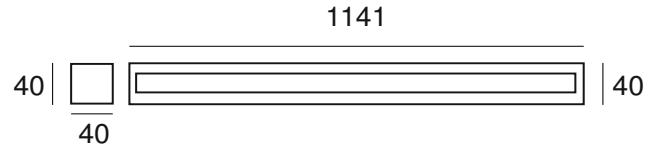

IP40 **IK07**



Caratteristiche elettriche/Electrical features:

Alimentazione/Power supply:	220-240Vac
Potenza/Power:	30W
Fattore di potenza/Power factor:	0,95
Alimentatore/Driver:	Incluso / Included
Indice Mac Adam/Mac Adam index:	3
Rischio fotobiologico/Photobiological risk:	RG0
Aspettativa di vita/Life expectation:	50.000h L80/B10

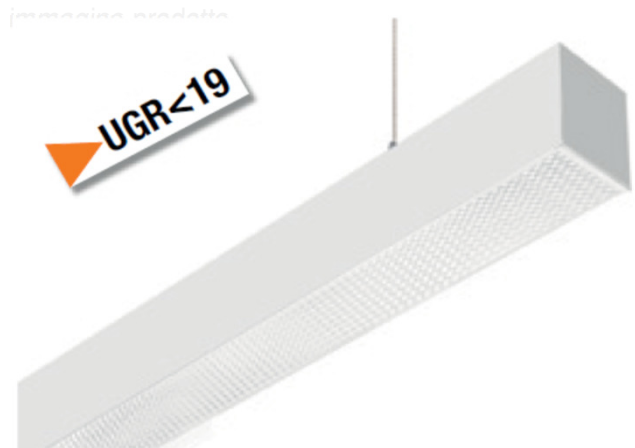

Caratteristiche illuminotecniche/Photometric features:

Tipo di LED/LED type:	504 LED SMD 3528
*Flusso luminoso/Luminous flux:	3900lm
CCT:	3000K
*Lm/W:	130lm/W
CRI:	90

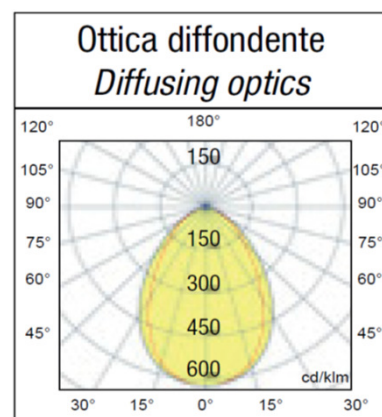

Conforme alle seguenti norme/Complying with the following standards:

Sicurezza/Safety:	Generale/General:	EN-60598-1
	Particolari/Particular:	EN-60598-2-1
	Moduli LED/LED Modules:	EN-62031+A1
Sicurezza fotobiologica/Photobiological safety:		EN 62471 (Risk exempt)
Esposizione umana ai campi elettromagnetici/Human exposure to electromagnetic fields:		EN-62493



RELCO group persegue una politica di continua ricerca e sviluppo, quindi si riserva di variare in qualsiasi momento e senza preavviso le caratteristiche dei prodotti.
RELCO group pursues a policy of continuous research and development and reserves the right to change at any time and without prior notice, the characteristics of the products.

*i dati hanno una tolleranza $\pm 10\%$ - data have a tolerance $\pm 10\%$

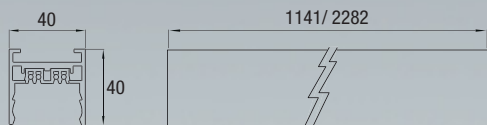
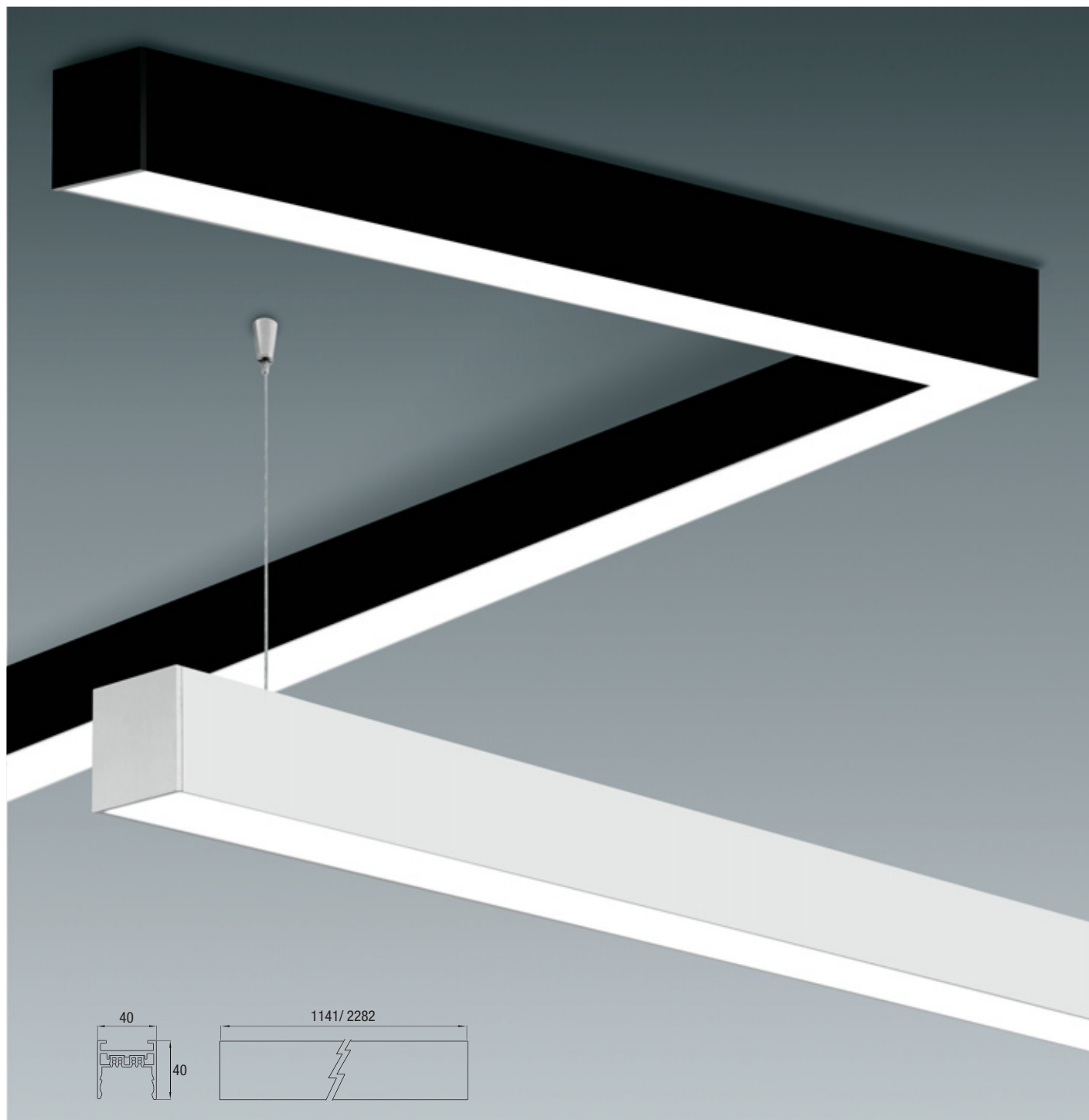
Sky system S-C 40x40A richiesta
On demand**0-10V****WIRELESS****LED Sky slim S-C dark light, opale, asimmetrica.**

Sistema luminoso modulare per file continue a sospensione o plafone in versione opale o con lenti, uffici, reception, supermarket, palestre. Elementi di giunzione di semplice utilizzo per linee continue o accessorio per angoli a 90°. Collegamento rapido con morsetto fast. Modulo cieco a richiesta predisposto per linea passante DALI, 0-10V. ed emergenza.

A richiesta modello Biemissione vedi pag.200.

Installazione: a sospensione e parete con accessorio (non incluso) o a plafone con accessorio (incluso).

Corpo: alluminio estruso anodizzato al naturale verniciato a polveri epossidiche RAL 9004.

Diffusore: in policarbonato trasparente ad incastro a filo + film microstrutturato UGR<19.

Diffusore asimmetrico e bi-asimmetrica: lenti in PMMA e diffusore trasparente.

Conforme alla norma: EN60598-1, RGO nessun rischio fotobiologico ai fini della norma EN62471.

Led: Samsung SMD mantenimento del flusso luminoso minimo al 80%: 50.000h (L80B10).

Driver multipotenza: Incluso > 50.000 h Fattore di potenza ≥0,95.

A richiesta: per quantità si esegue il settaggio dedicato.

Prodotto conforme alle direttive:

LED Sky slim S-C dark light, opal, asymmetrical.

Modular light system for continuous rows, suspension or ceiling, in opal version or with lenses, for offices, receptions, supermarkets, gyms. Easy to use joining elements for continuous lines or 90° angle accessory. Quick connection with fast clamp. Dummy model on demand designed for DALI feedthrough line, 0-10V. and emergency.

Installation: suspension or wall with accessory (not included) or on ceiling with accessory (included).

Body: natural anodised extruded aluminium painted with RAL 9004 epoxy powders.

Diffuser: in flush joint transparent polycarbonate + microstructured film UGR <19.

Asymmetric and bi-asymmetric diffuser: lens in clear PMMA and transparent diffuser.

Compliant with standard: EN60598-1, RGO no photobiological risk for the purposes mentioned in standard EN62471.

Led: Samsung SMD maintenance of 80% minimum luminous flux: 50,000h (L80B10).

Multipower driver: Included > 50,000 h Power factor ≥0.95.

On request: the dedicated setting is performed by quantity.

Product compliant with directives:

Sky system per il Food

110V. ON REQUEST

A richiesta - On demand



NEW



Grazie ai moduli Sky system con ottiche LED dedicate alla categoria **FOOD** con la più recente tecnologia per rendere i bianchi ancora più bianchi e i colori più intensi e brillanti, nate per attirare e coinvolgere i clienti grazie alla perfetta illuminazione e all'elevata resa cromatica ad alta efficienza energetica. Rivenditori di generi alimentari vogliono che i loro prodotti freschi come frutta, verdura, pane e carne, siano il più attraente possibile. E i produttori di apparecchi di illuminazione li stanno aiutando, lo fanno attraverso la creazione di sistemi di illuminazione che sottolineano i rossi di carni fresche e pomodori per esempio o la luce calda per accentuare la doratura dei prodotti da forno. La luce corretta può avere un impatto estremamente positivo sulla percezione dello shopping; creando un effetto quasi appetitoso.

CrispWhite employs the latest technology involving white LED lighting to light up white shades and colours look brighter. Attracting, engaging and converting customers with impeccable lighting from a single energy-efficient light source. Food retailers want their fresh products such as fruit, vegetables, bread and meat, to be as attractive as possible. Lighting equipment manufacturers are helping them in this sense by creating lighting systems that emphasise, for instance, the red shades of fresh meat and tomatoes or the warm brown-yellow hues for fresh bread. The right lighting can have an extremely positive impact on the perception of your shopping experience by creating an almost appetising effect.



Ottica bread

la luce calda rivela la naturale colorazione di farinacei e prodotti di pasticceria

the warm light accentuates the natural coloring of starchy and pastry products



Ottica meat

accentua il colore della carne e dei salumi e ne risalta la freschezza.

accentuates the color of meat and cured meats and enhances their freshness.



Ottica fruit -vegetables

aumenta la sensazione del cliente di acquistare di frutta e verdura fresche appena colte.

increases the customer's feeling of buying freshly picked fresh fruit and vegetables.



Ottica fish

con luce fredda "glaciale" risalta la naturale freschezza del pesce e dei crostacei appena pescati

with cold "glacial" light, the natural freshness of freshly caught fish and crustaceans stands out



Ceiling/suspended/wall

Sky system S-C 40x40

A richiesta
On demand



WIRELESS



220-240V 50/60Hz



IK07

IP40

Sky system S-C 40x40

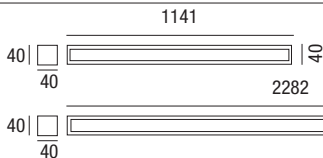

CRI 90

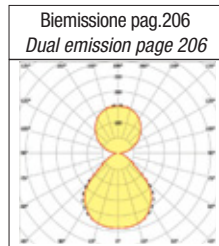
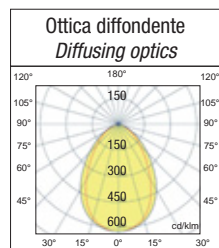

colour	W max	N°Led SMD	Vac	lm output	lm/W	K	L (mm)	pcs/pallets	Kg	CELL
B	30	234 led 3528	220-240	3900	130	3000	1141	-	2.00	1003K
B	30	234 led 3528	220-240	3900	130	4000	1141	-	2.00	1004K
DALI 2	B	234 led 3528	220-240	3900	130	3000	1141	-	2.00	1003KDA
DALI 2	B	234 led 3528	220-240	3900	130	4000	1141	-	2.00	1004KDA
N	30	234 led 3528	220-240	3900	130	3000	1141	-	2.00	100B3K
N	30	234 led 3528	220-240	3900	130	4000	1141	-	2.00	100B4K
DALI 2	N	234 led 3528	220-240	3900	130	3000	1141	-	2.00	100B3KDA
DALI 2	N	234 led 3528	220-240	3900	130	4000	1141	-	2.00	100B4KDA
B	50	468 led 3528	220-240	6500	130	3000	2282	-	4.00	2003K
B	50	468 led 3528	220-240	6500	130	4000	2282	-	4.00	2004K
DALI 2	B	468 led 3528	220-240	6500	130	3000	2282	-	4.00	2003KDA
DALI 2	B	468 led 3528	220-240	6500	130	4000	2282	-	4.00	2004KDA
N	50	468 led 3528	220-240	6500	130	3000	2282	-	4.00	200B3K
N	50	468 led 3528	220-240	6500	130	4000	2282	-	4.00	200B4K
DALI 2	N	468 led 3528	220-240	6500	130	3000	2282	-	4.00	200B3KDA
DALI 2	N	468 led 3528	220-240	6500	130	4000	2282	-	4.00	200B4KDA



Per lampade cablate in emergenza (aggiungere /EM dopo il codice) sovrapprezzo del 20%.
For wired emergency lights (add /EM after the code) 20% extra charge.

Sky system S-C 40x40 asimmetrica

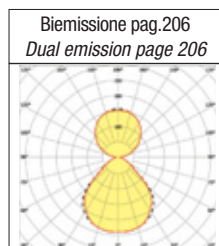
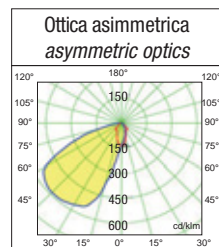
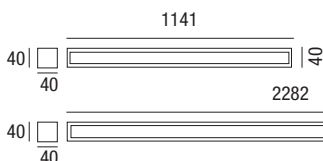
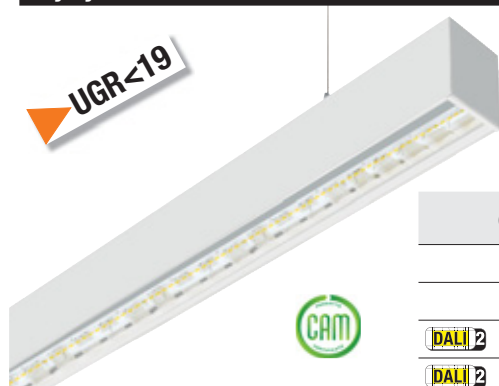

colour	W max	N°Led SMD	Vac	lm output	lm/W	K	L (mm)	pcs/pallets	Kg	CELL
B	30	234 led 3528	220-240	3900	130	3000	1141	-	2.00	100AS3K
B	30	234 led 3528	220-240	3900	130	4000	1141	-	2.00	100AS4K
DALI 2	B	234 led 3528	220-240	3900	130	3000	1141	-	2.00	100AS3KDA
DALI 2	B	234 led 3528	220-240	3900	130	4000	1141	-	2.00	100AS4KDA
N	30	234 led 3528	220-240	3900	130	3000	1141	-	2.00	100ASB3K
N	30	234 led 3528	220-240	3900	130	4000	1141	-	2.00	100ASB4K
DALI 2	N	234 led 3528	220-240	3900	130	3000	1141	-	2.00	100ASB3KDA
DALI 2	N	234 led 3528	220-240	3900	130	4000	1141	-	2.00	100ASB4KDA
B	50	468 led 3528	220-240	6500	130	3000	2282	-	4.00	200AS3K
B	50	468 led 3528	220-240	6500	130	4000	2282	-	4.00	200AS4K
DALI 2	B	468 led 3528	220-240	6500	130	3000	2282	-	4.00	200AS3KDA
DALI 2	B	468 led 3528	220-240	6500	130	4000	2282	-	4.00	200AS4KDA
N	50	468 led 3528	220-240	6500	130	3000	2282	-	4.00	200ASB3K
N	50	468 led 3528	220-240	6500	130	4000	2282	-	4.00	200ASB4K
DALI 2	N	468 led 3528	220-240	6500	130	3000	2282	-	4.00	200ASB3KDA
DALI 2	N	468 led 3528	220-240	6500	130	4000	2282	-	4.00	200ASB4KDA



Per lampade cablate in emergenza (aggiungere /EM dopo il codice) sovrapprezzo del 20%.
For wired emergency lights (add /EM after the code) 20% extra charge.

Sky system S-C 40x40

A richiesta
On demand



WIRELESS



220-240V 50/60Hz



IK07

IP40

Sky slim system S-C bi-asimmetrica

UGR < 19

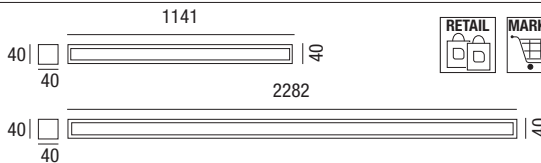

Ottica bi-asimmetrica bi-asymmetric optics

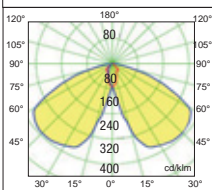

Biemissione pag.206 Dual emission page 206

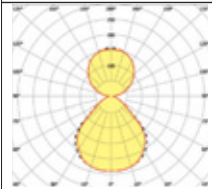

colour	W max	N°Led SMD	Vac	lm output	lm/W	K	L (mm)	pcs/pallets	Kg	CELL
B	30	234 led 3528	220-240	3900	130	3000	1141	-	2.00	100BAS3K
B	30	234 led 3528	220-240	3900	130	4000	1141	-	2.00	100BAS4K
DALI 2	B	234 led 3528	220-240	3900	130	3000	1141	-	2.00	100BAS3KDA
DALI 2	B	234 led 3528	220-240	3900	130	4000	1141	-	2.00	100BAS4KDA
N	30	234 led 3528	220-240	3900	130	3000	1141	-	2.00	100BASB3K
N	30	234 led 3528	220-240	3900	130	4000	1141	-	2.00	100BASB4K
DALI 2	N	234 led 3528	220-240	3900	130	3000	1141	-	2.00	100BASB3KDA
DALI 2	N	234 led 3528	220-240	3900	130	4000	1141	-	2.00	100BASB4KDA
B	50	468 led 3528	220-240	6500	130	3000	2282	-	4.00	200BAS3K
B	50	468 led 3528	220-240	6500	130	4000	2282	-	4.00	200BAS4K
DALI 2	B	468 led 3528	220-240	6500	130	3000	2282	-	4.00	200BAS3KDA
DALI 2	B	468 led 3528	220-240	6500	130	4000	2282	-	4.00	200BAS4KDA
N	50	468 led 3528	220-240	6500	130	3000	2282	-	4.00	200BASB3K
N	50	468 led 3528	220-240	6500	130	4000	2282	-	4.00	200BASB4K
DALI 2	N	468 led 3528	220-240	6500	130	3000	2282	-	4.00	200BASB3KDA
DALI 2	N	468 led 3528	220-240	6500	130	4000	2282	-	4.00	200BASB4KDA

EMERGENCY Per lampade cablate in emergenza (aggiungere /EM dopo il codice) sovrapprezzo del 20%.
For wired emergency lights (add /EM after the code) 20% extra charge.

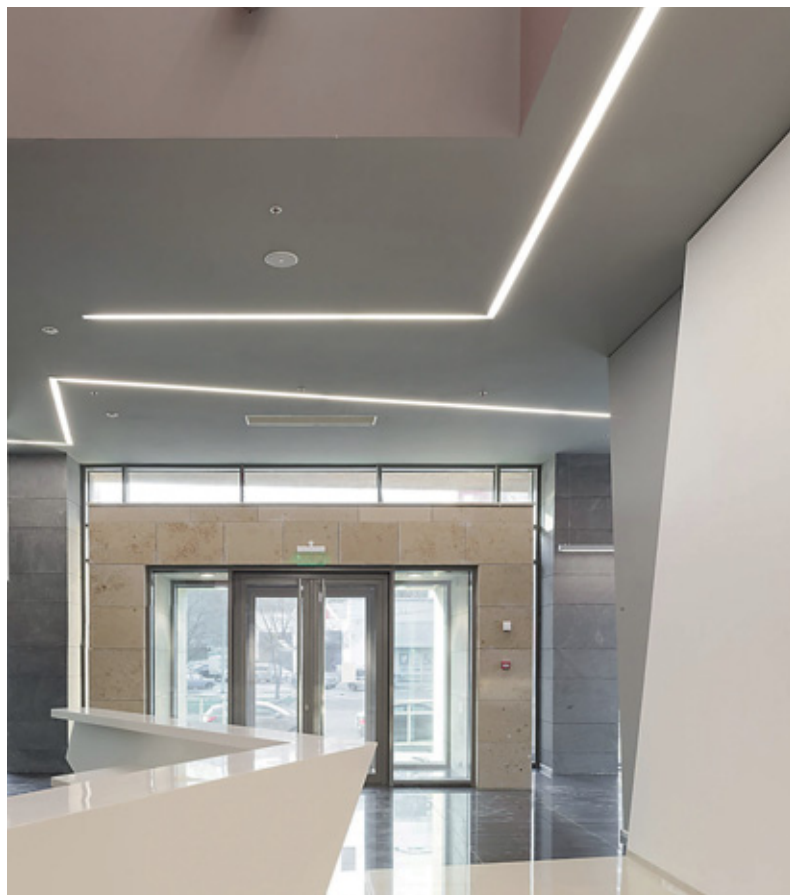

Ottica asimmetrica - Asymmetric optics

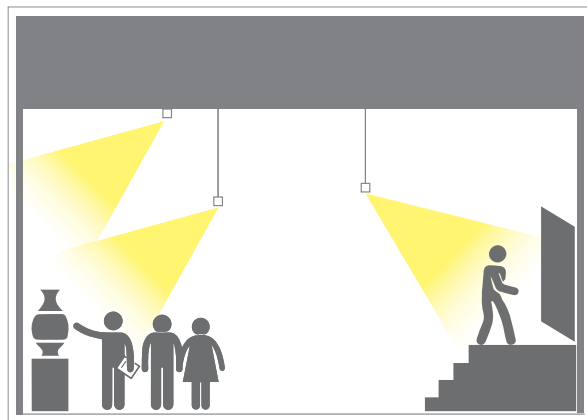

Ottica bi-asimmetrica - Bi-asymmetric optics

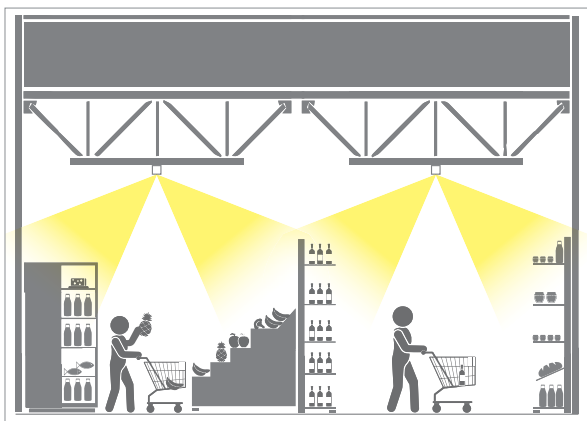





Ceiling/suspended/wall





Ceiling/suspended/wall

Sky system accessori - accessories

Serie di accessori che consentono il fissaggio in linea della famiglia Sky Slim system .
Series of accessories to fix the Sky Slim system range in line.

Accessori a richiesta - Accessoires on demand

Modulo cieco - predisposto con cablaggio per linee passanti e DALI o 0-10V. + EMERGENZA.

Non-luminous pipe - set up with wiring for feedthrough and DALI or 0-10V lines. + EMERGENCY.

Colour		L [mm]	pcs	Kg	Code
B	7 FILI/WIRE	1141	001	3,80	100/SL/SC
N	7 FILI/WIRE	1141	001	3,80	100B/SL/SC

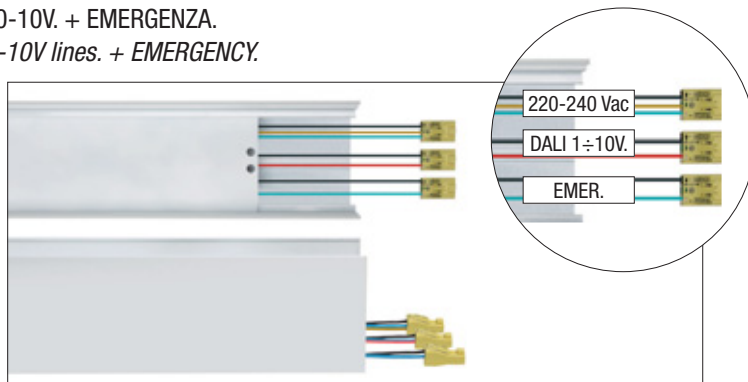
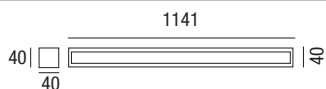

Per cablaggio emergenza aggiungere -E dopo il codice
For emergency wiring add -E after the code

Kit di alimentazione Power supply kit

Colour	Cavo	pcs	Kg	Code
B	3x1,5	1	0,01	102/3/C
B	5x1,5	1	0,01	102/5/C
N	3x1,5	1	0,01	102B/3/C
N	5x1,5	1	0,01	102B/5/C

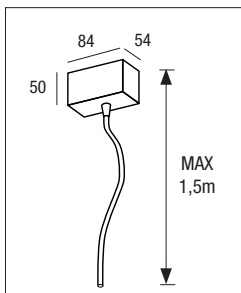

Staffa di giunzione e mascherina per fila continua Junction bracket and continuous line screen

Colour	pcs	Kg	Code
B	1	0,01	100/SL/SKY

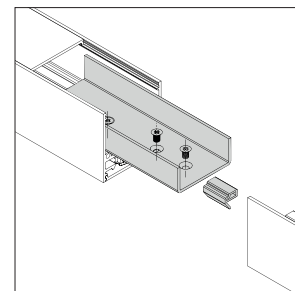
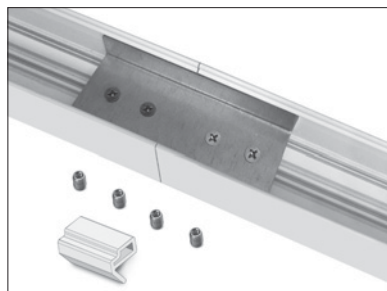

La mascherina evita che il flusso luminoso trafile tra le due testate
The mask prevents the luminous flux from leaking between the two heads

KIT Congiunzione a L, luminoso 15W - 1950lm KIT L-shaped angular joint 15W - 1950lm

Colour	pcs	Kg	K	Code
B	1	0,20	3000	100/3K/SC
N	1	0,20	3000	100B/3K/SC
B	1	0,20	4000	100/4K/SC
N	1	0,20	4000	100B/4K/SC

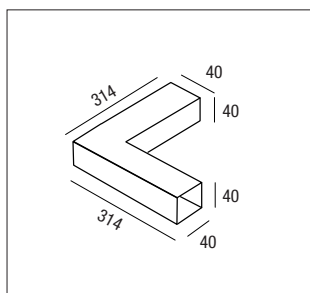

KIT Congiunzione a T, luminoso 23W - 2650lm KIT L-shaped angular joint 23W - 2650lm

Colour	pcs	Kg	K	Code
B	1	0,20	3000	101/3K/SC
N	1	0,20	3000	101B/3K/SC
B	1	0,20	4000	101/4K/SC
N	1	0,20	4000	100B1/4K/SC

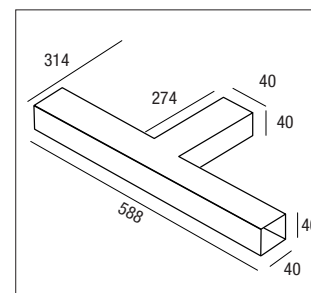

Cavo per sospensione
Suspension cable

Colour	pcs	Kg	PCS	Code
B	001	0,250	1 cavi/cables	103/S

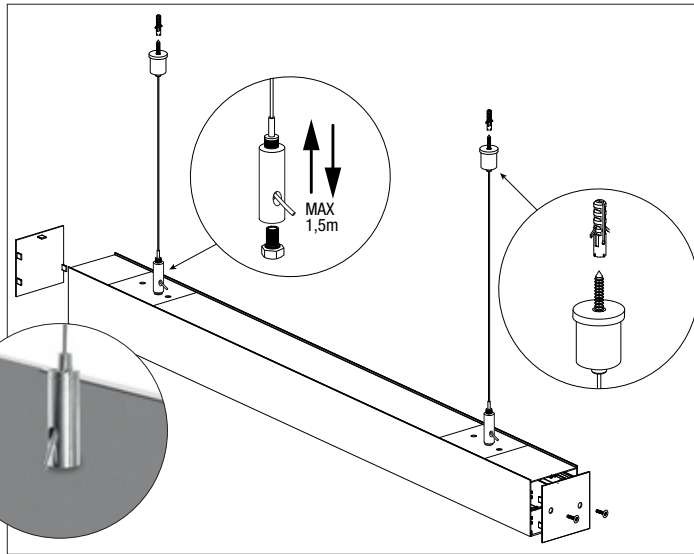
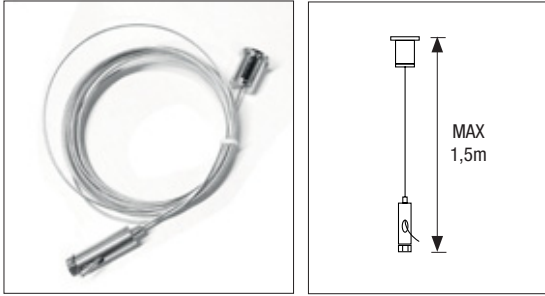

Staffa per parete
wall bracket

Colour	Kg	PCS	Code
B	0,050	2 x profilo/profile L.1141	104/2/C
B	0,050	3 x profilo/profile L. 2282	104/3/C

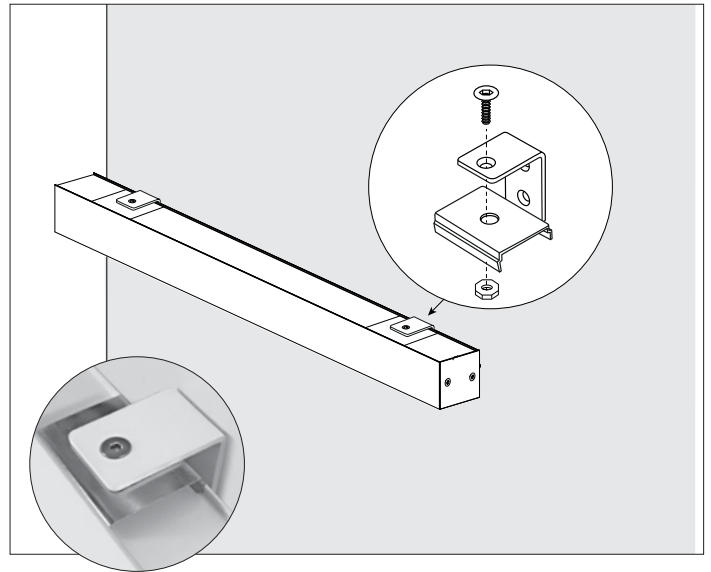
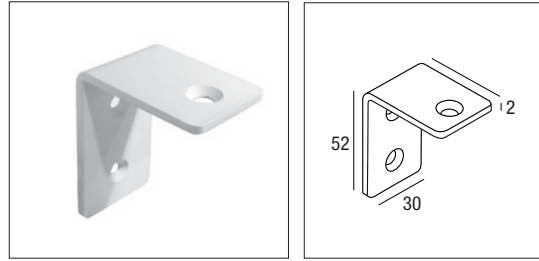

Kit Spot
Spot Kit

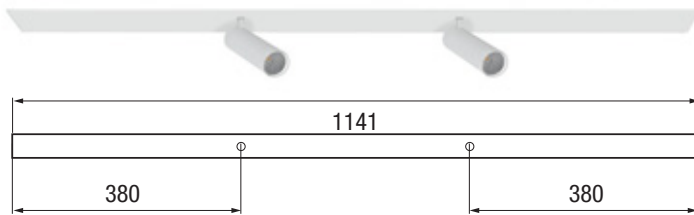

Cover 2 spot L.1141 mm.

Colour	W	lm output	K	Angolo	Code
B	2x10	2x1700	3000	15 (36)	2SPOT/3K/15
B	2x10	2x1700	4000	15 (36)	2SPOT/4K/15
N	2x10	2x1700	3000	15 (36)	2SPOT/B/3K/15
N	2x10	2x1700	4000	15 (36)	2SPOT/B/4K/15

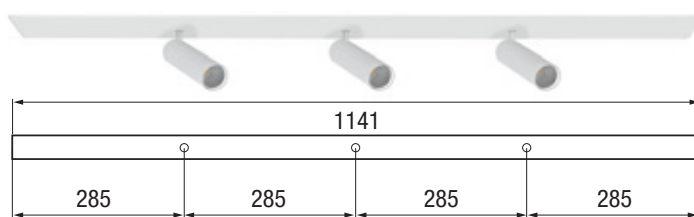

Cover 3 spot L.1141 mm.

Colour	W	lm output	K	Angolo	Code
B	3x10	3x1700	3000	15 (36)	3SPOT/3K/15
B	3x10	3x1700	4000	15 (36)	3SPOT/4K/15
N	3x10	3x1700	3000	15 (36)	3SPOT/B/3K/15
N	3x10	3x1700	4000	15 (36)	3SPOT/B/4K/15

Spot 15°

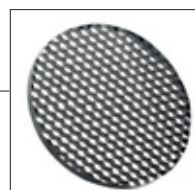
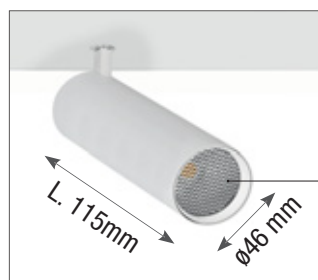
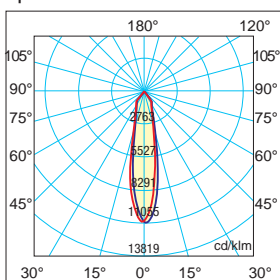

Frangiluce nido d'ape INCLUSO.
INCLUDED Honeycomb louvre

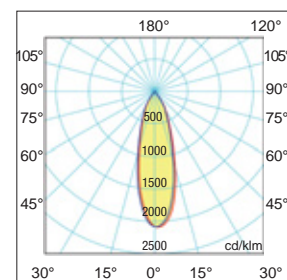

Spot 36° a richiesta on demand

Sky system accessori - accessories

Ottica a richiesta - Optic on demand

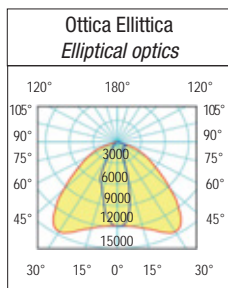

A richiesta ottica ellittica 30°x90°
Ideale per illuminare ambienti con alte scaffalature o lunghi corridoi per la vendita al dettaglio, in modo da avere una luce diffusa e uniforme.
On request elliptical optic 30°x90°
Ideal for lighting environments with high shelves or long corridors for retail, so as to have a uniformly diffused light.

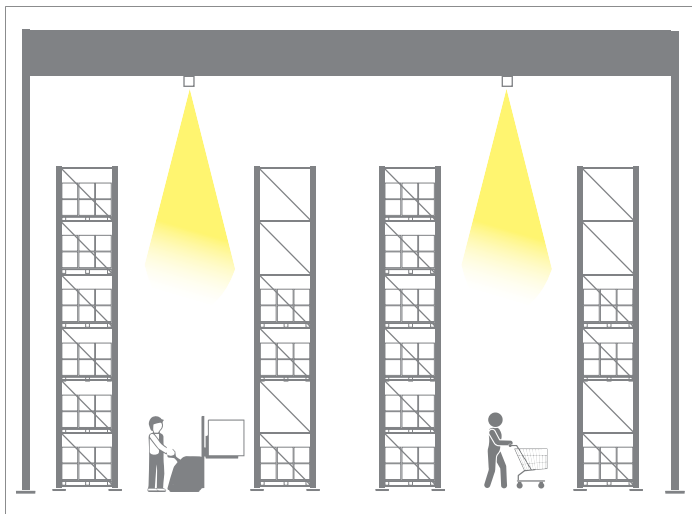

Biemissione a richiesta

Dual emission on request

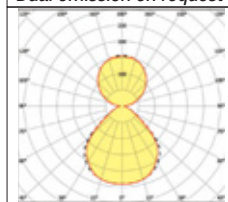

Sistema biemissione a richiesta - dual emission system on demand

Sistema a biemissione applicabile a tutti i modelli **Led Sky system** lineari misura 1141mm. e 2282mm.

Ideale per illuminazione rasente il muro, con doppia accensione.

A richiesta con sovrapprezzo del 20%. (aggiungere /DM dopo il codice).

Non disponibile per Congiunzioni luminose a "T" o a "C".

*Dual emission system applicable to all linear models **Led Sky system** measuring 1141mm. and 2282mm.*

Ideal for lighting close to the wall, with double switching.

On request with 20% extra charge (add / DM after the code).

Not available for "T" or "C" Light Junctions.

