

## 310-1/VI

### LAMPENFASSUNG FÜR METALLDAMPFLAMPEN (ENTLADUNGSLAMPEN) LAMPHOLDER FOR SODIUM VAPOUR DISCHARGE LAMPS

#### Technische Daten

##### Technical data





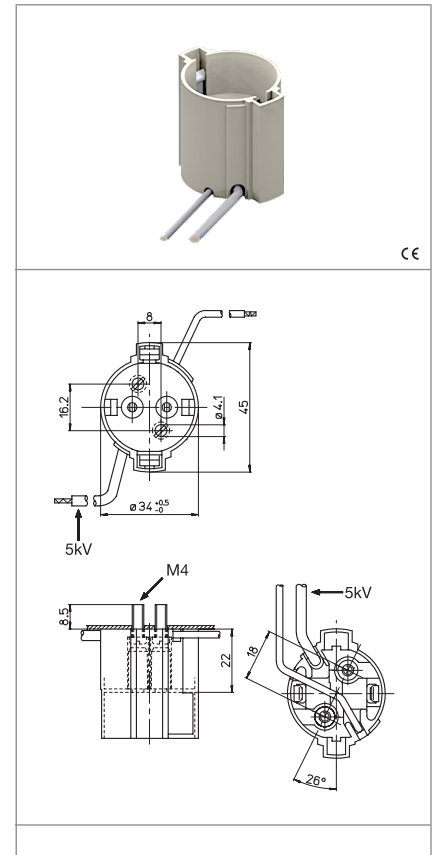

- Lampensockel - Lamp Cap	PG12-1
- Nennstrom und Nennspannung - Rated current and voltage	4A-500V
- Maximale Betriebstemperatur (IEC) - Maximum operating temperature (IEC)	T200
- Schutzgrad - Protection index	IP20
- Überspannungskategorie - Impulse withstand category	III

#### Merkmale

##### Characteristics

- Gehäuse aus PET,  
- Natural PET body
- Nickel Kontakt  
- Nickel contacts
- Kriechstreckenabstand: 10mm  
- Creepage distances: 10 mm



 Schraubbefestigung screw fixing	 an leitung punktgeschweisster Kontakt conductor electrically spot-welded to the contact	 Bereich mehrdrige Leitungen mit Aderendhülsen section of the flexible conductor with ferrule	 Bereich mehrdrige Leitungen mit Aderendhülsen section of the flexible conductor with ferrule
 Leitungslänge flexibel flexible wire length 20 cm	 geeignet für eine Zündspannung von... suitable for impulse ignition voltage up to... 5kV		

#### Prüfzeichen

##### Quality marks

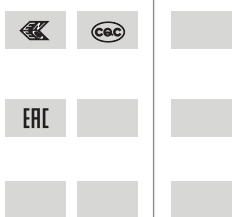

#### Europäische Richtlinien

##### European directives

Gemäß "RoHS"  
"RoHS" compliant  
  
Unterliegt nicht "WEEE"  
Not subject to "WEEE"

#### Gewichte und Verpackung

##### Weights and packaging

Art. Codice prodotti Product references	g Peso netto Net weight	n° pz per sacco per bag	n° pz per scatola per box	n° pz per cartone per carton
310-1/VI	33,3		50	

#### Bemerkung

##### Notes