

683/V

683/VR

VERBINDUNGSKLEMME MIT SICHERUNGSHALTER
TERMINAL BLOCKS WITH FUSEHOLDER FOR LIGHTING FIXTURES

Technische Daten

Technical data





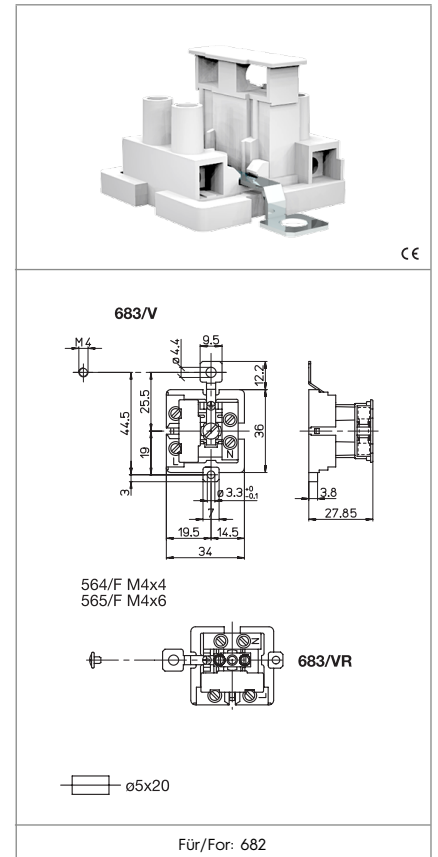

- Pole	2P+E
- Poles	
- Nennstrom und Nennspannung	2,5W/6,3A-250V
- Rated current and voltage	6A-400V
- Maximale Betriebstemperatur (IEC)	T70
- Maximum operating temperature (IEC)	
- Schutzgrad	IP20
- Protection index	

Merkmale

Characteristics

- ...R= mit screwed earth facility
- ...R= with screwed earth facility
- Gehäuse aus polycarbonat, weiß
- White polycarbonate body
- Messingkontakt
- Internal part in brass
- Erdung aus vernickeltem Stahl
- Earth connection in nickel plated steel



 Schraubbefestigung screw fixing	 Abisolierung starre und flexible Leitungen rigid and flexible wires stripping	 Schraubkontakte screw terminals	 Klemme eingang: Schraubkontakte Klemme ausgang: Schraubkontakte input side: screw output side: screw
 Schraubklemmen screw terminals	 Abisolierung starre und flexible Leitungen rigid and flexible wires stripping	 564/F 565/F	

Prüfzeichen
Quality marks

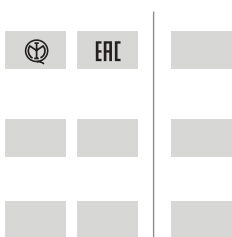

Europäische Richtlinien
European directives

gemäß "RoHS"
"RoHS" compliant
unterliegt nicht "WEEE"
Not subject to "WEEE"

Gewichte und Verpackung
Weights and packaging

Artikel/Art Produktinweise Product references	g Nettogewicht Net weight	n° pz pro Beutel per bag	n° pz pro Box per box	n° pz pro Karton per carton
683/V	14,3		200	
683/VR	18,2		200	

Bemerkung

Notes