

401/VL

LAMPENFASSUNG FÜR KOMPAKTSTOFFLAMPEN (TC-S) LAMPHOLDER FOR COMPACT FLUORESCENT LAMPS (TC-S)

Technische Daten

Technical data





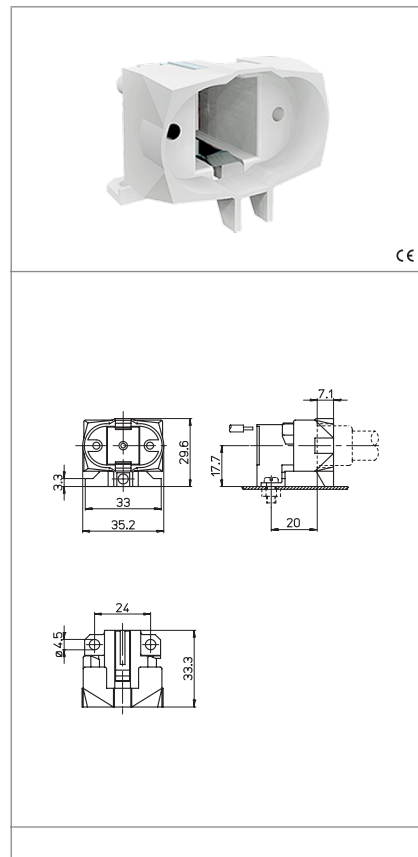

- Lampensockel - Lamp Cap	G23
- Nennstrom und Nennspannung - Rated current and voltage	2A-250V
- Maximale Betriebstemperatur (IEC) - Maximum operating temperature (IEC)	T140
- Schutzgrad - Protection index	IP20
- Überspannungskategorie - Impulse withstand category	III

Merkmale

Characteristics

- Gehäuse aus PBT, weiss
- White PBT body
- Kupferlegierte Kontakte
- Copper alloy contacts



 Schraubbefestigung screw fixing	 Lichtpunkthöhe ab Oberfläche Leuchtenblech lamp centre height (from the top of the metal plate)	 Steckkontakte mit 1 Loch push-wire terminals with 1 hole	 Feste Leitungsabschnitte rigid conductor section
 Leitungsabsolierung rigid wires stripping	 130		

Prüfzeichen

Quality marks

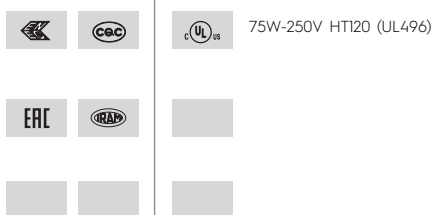

Europäische Richtlinien

European directives

Gemäß "RoHS"
"RoHS" compliant

Unterliegt nicht "WEEE"
Not subject to "WEEE"

Gewichte und Verpackung

Weights and packaging

Art. Codice prodotti Product references	g Peso netto Net weight	n° pz per sacco per bag	n° pz per scatola per box	n° pz per cartone per carton
401/VL	11,2	500	200	

Bemerkung

Notes