

2423/V-d1-T

2423/V-d2-T

2423/V-d3-T

**LAMPENFASSUNG FÜR KOMPAKTSTOFFLAMPEN (TC-D, TC-T)**  
**LAMPHOLDERS FOR COMPACT FLUORESCENT LAMPS (TC-D, TC-T)**

**Technische Daten**

Technical data





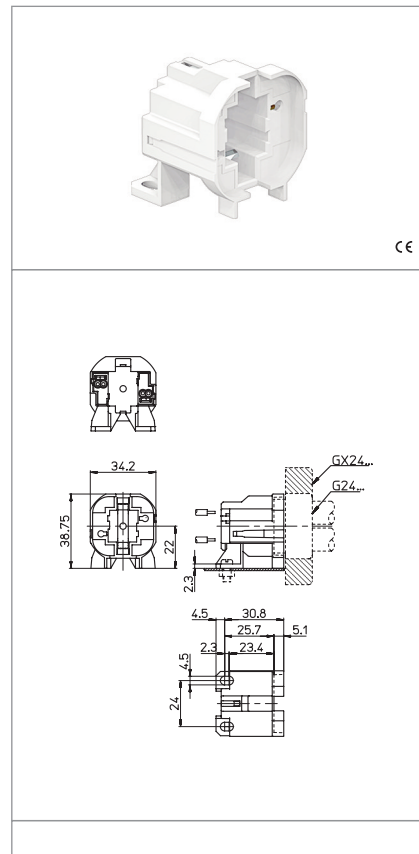

- Lampensockel - Lamp cap	G24d-1-2-3 GX24d-1-2-3
- Nennstrom und Nennspannung - Rated current and voltage	2A-500V
- Maximale Betriebstemperatur (IEC) - Maximum operating temperature (IEC)	T140
- Schutzgrad - Protection index	IP20
- Überspannungskategorie - Impulse withstand category	III

**Merkmale**

Characteristics

- Gehäuse aus PBT, weiss  
- White PBT body
- Kupferlegierte Kontakte  
- Copper alloy contacts



 Schraubbefestigung screw fixing	 Lichtpunkthöhe ab Oberfläche Leuchtenblech lamp centre height (from the top of the metal plate)	 Steckkontakte mit 2 Löchern push-wire terminals with 2 holes	 Feste Leitungsabschnitte rigid conductor section
 Leitungsabsisolierung rigid wires stripping	 mit Leitungsdurchführungslöcher with wires guidance holes	 Schutzklasse II class II insulated	

**Prüfzeichen**  
Quality marks

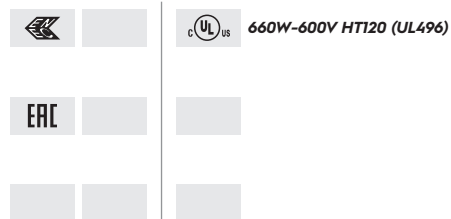

**Europäische Richtlinien**  
European directives

gemäß "RoHS"  
"RoHS" compliant  
unterliegt nicht "WEEE"  
Not subject to "WEEE"

**Gewichte und Verpackung**  
Weights and packaging

Artikel/Art. Produktinweise Product references	g Nettogewicht Net weight	n° pz pro Beutel per bag	n° pz pro Box per box	n° pz pro Karton per carton
2423/V-d1-T	13	500		
2423/V-d2-T	13	500		
2423/V-d3-T	13	500		

**Bemerkung**

Notes