

204/SZ

204/SZ-TF

LAMPENFASSUNG FÜR HALOGENHOCHVOLTlampEN
LAMPHOLDER FOR MAIN VOLTAGE TUNGSTEN HALOGEN INCANDESCENT LAMP

Technische Daten

Technical data

| | |
|--|---------|
| - Lampensockel - Lamp Cap | R7s |
| - Nennstrom und Nennspannung - Rated current and voltage | 6A-250V |
| - Maximale Betriebstemperatur (IEC) - Maximum operating temperature (IEC) | T250 |
| - Überspannungskategorie - Impulse withstand category | III |









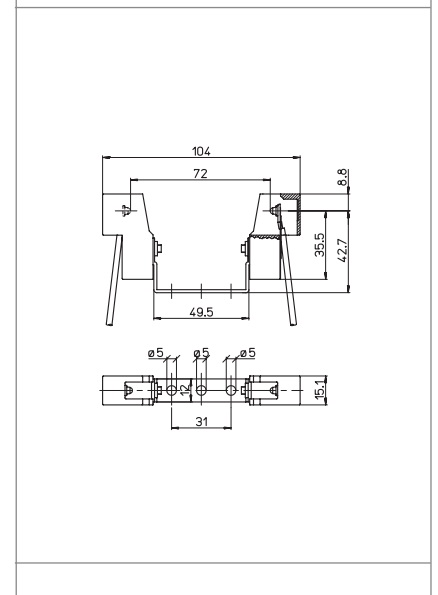

CE

Merkmale

Characteristics

- Bügel gemäß Klasse II isoliert
- Zinc plated steel class II insulated support



| | | | |
|--|---|--|--|
|  Schraubbefestigung screw fixing |  an leitung gecrimpter Kontakt conductor crimped to the contact |  Bereich mehradrige Leitungen mit Aderendhülsen section of the flexible conductor with ferrule |  Bereich mehradrige Leitungen mit Aderendhülsen section of the flexible conductor with ferrule |
|  Leitungslänge flexibel flexible wire length 25 cm |  S-204/1 |  S-204/112 | |

Prüfzeichen
Quality marks

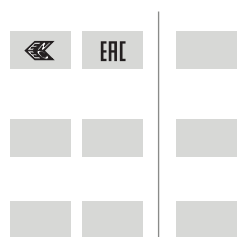

Europäische Richtlinien
European directives

- ⌘ Gemäß "RoHS"
"RoHS" compliant
- ⌘ Unterliegt nicht "WEEE"
Not subject to "WEEE"

Gewichte und Verpackung
Weights and packaging

| Art. Codice prodotti Product references | g Peso netto Net weight | n° pz per sacco per bag | n° pz per scatola per box | n° pz per cartone per carton |
|---|-------------------------------|-------------------------------|---------------------------------|------------------------------------|
| 204/SZ | 70,9 | | 20 | |
| 204/SZ-TF | 69,7 | | 20 | |
| | | | | |
| | | | | |
| | | | | |
| | | | | |
| | | | | |

Bemerkung

Notes

Bemerkung

Note

ARTIKEL AUS STEATIT

Produkte, die aus Steatit formgespritzt sind, durchlaufen dimensionale Veränderungen bei durch Austrocknung bei hohen Temperaturen. Daher ist ein Hinweis auf die in DIN40680 angegebenen Toleranzen anzugeben, Mittelwert bezogen auf die Nennwerte gemäß Angabe im Katalog.

ARTICLES IN STEATITE

Products moulded in steatite undergo dimensional changes during the high temperature curing process. Therefore reference must be made to the tolerance stated in DIN 40680, middle values referred to the nominal values stated in the catalogue.

| ABMESSUNGEN DIMENSIONS | Toleranzen/Tolerance |
|---------------------------|----------------------|
| | DIN40680 |
| Fino a/Up to 4 | ±0,15 |
| Von/From 4,1 bis/to 6 | ±0,20 |
| Von/From 6,1 bis/to 8 | ±0,25 |
| Von/From 8,1 bis/to 10 | ±0,30 |
| Von/From 10,1 bis/to 13 | ±0,35 |
| Von/From 13,1 bis/to 16 | ±0,40 |
| Von/From 16,1 bis/to 20 | ±0,45 |
| Von/From 20,1 bis/to 25 | ±0,50 |
| Von/From 25,1 bis/to 30 | ±0,55 |
| Von/From 30,1 bis/to 35 | ±0,60 |
| Von/From 35,1 bis/to 40 | ±0,65 |
| Von/From 40,1 bis/to 45 | ±0,70 |
| Von/From 45,1 bis/to 50 | ±0,80 |
| Von/From 50,1 bis/to 55 | ±0,90 |
| Von/From 55,1 bis/to 60 | ±1,00 |