

linM

light inside Multisystem









La luce prende vita all'interno della gamma di binari a bassa tensione **MULTISYSTEM® EVO** con diverse soluzioni modulari pensate sia per applicazioni dove esiste o viene installato un reticolo di binari che per quelle dove servono configurazioni standalone.

Ecco quindi nascere **SENZAFINE**, il prodotto che permette di creare una **"linea infinita" di luce** all'interno dei binari; disponibile in moduli di **diverse lunghezze** e con diverse **ottiche e schermi** che garantiscono una ampia scelta per poter comporre il proprio progetto illuminotecnico in modo ottimale a seconda delle esigenze. Da qui lo sviluppo della gamma **MULTISYSTEM READY**; soluzioni pronte all'uso che hanno come base i **binari**, pensate per utilizzi e applicazioni diverse con luce lineare integrata, diretta e/o indiretta, facili da installare ma sempre estremamente flessibili grazie alla presenza del binario.

*Light takes life inside the **MULTISYSTEM® EVO** low voltage tracks with different modular solutions developed both for applications where a track system already exists or is being installed and in those where standalone configurations are necessary.*

*Hence the development of **SENZAFINE**, the product that makes the creation of an **"endless light line"** possible **inside tracks**. The system is available in different lengths and with various optics and lens that create countless lighting solutions for all project needs.*

*The next logical step was the development of the **MULTISYSTEM READY** product range. Ready to use solutions based on **tracks** meant for different uses and applications with integrated direct and/or indirect light; easy to install and always flexible thanks to track infrastructure.*

SENZAFINE

APPLICAZIONI / <i>APPLICATIONS</i>	8
SENZAFINE - GAMMA / <i>SENZAFINE RANGE</i>	10
LA LUCE GIUSTA NEL POSTO GIUSTO / <i>THE RIGHT LIGHT AT THE RIGHT PLACE</i>	11
CONFIGURATORE CODICI PRODOTTO / <i>PRODUCT CODE CONFIGURATOR</i>	12
COMPOSIZIONE MECCANICA E COMPONENTI SINGOLI / <i>MECHANICAL COMPOSITION AND SINGLE COMPONENTS</i>	14
PERFORMANCE DI PRODOTTO E DATI TECNICI / <i>PRODUCT PERFORMANCES AND TECHNICAL DATA</i>	20
SENZAFINE CROSS - APPLICAZIONI / <i>APPLICATIONS</i>	30
SENZAFINE CROSS - CONFIGURATORE CODICI PRODOTTO / <i>PRODUCT CODE CONFIGURATOR</i>	37
SENZAFINE CROSS - PERFORMANCE DI PRODOTTO E DATI TECNICI / <i>PRODUCT PERFORMANCES AND TECHNICAL DATA</i>	39
SENZAFINE ADJUSTABLE - APPLICAZIONI / <i>APPLICATIONS</i>	48
SENZAFINE ADJUSTABLE - CONFIGURATORE CODICI PRODOTTO / <i>PRODUCT CODE CONFIGURATOR</i>	50
SENZAFINE ADJUSTABLE - PERFORMANCE DI PRODOTTO E DATI TECNICI / <i>PRODUCT PERFORMANCES AND TECHNICAL DATA</i>	52
SENZAFINE TWIST - APPLICAZIONI E GAMMA / <i>APPLICATIONS AND RANGE</i>	63
SENZAFINE TWIST - CONFIGURATORE CODICI PRODOTTO / <i>PRODUCT CODE CONFIGURATOR</i>	65

SENZAFINE TWIST - PERFORMANCE DI PRODOTTO E DATI TECNICI / <i>PRODUCT PERFORMANCES AND TECHNICAL DATA</i>	67
SENZAFINE TWIST CROSS - APPLICAZIONI E GAMMA / <i>APPLICATIONS AND RANGE</i>	69
SENZAFINE TWIST CROSS - CONFIGURATORE CODICI PRODOTTO / <i>PRODUCT CODE CONFIGURATOR</i>	71
SENZAFINE TWIST CROSS - PERFORMANCE DI PRODOTTO E DATI TECNICI / <i>PRODUCT PERFORMANCES AND TECHNICAL DATA</i>	73

MULTISYSTEM READY

L26R - APPLICAZIONI / <i>APPLICATIONS</i>	75
L26R - BINARIO A SOSPENSIONE CON LUCE BIEMISSIONE / <i>SUSPENDED TRACK WITH DOUBLE EMISSION LIGHT</i>	76
L26R - CONFIGURATORE CODICE E DATI TECNICI / <i>CODE CONFIGURATOR AND TECHNICAL DATA</i>	77
L26R - COMPOSIZIONE MECCANICA E IDEE DI COMPOSIZIONE / <i>MECHANICAL COMPOSITION AND COMPOSITION IDEAS</i>	79
H26 - APPLICAZIONI / <i>APPLICATIONS</i>	81
H26 - BINARIO A SOSPENSIONE PER FILA CONTINUA CON LUCE INDIRECTA / <i>SUSPENDED IN TROW TRACK WITH INDIRECT LIGHT</i>	82
H26 - CONFIGURATORE CODICE/ <i>CODE CONFIGURATOR</i>	83
H26 - PERFORMANCE DI PRODOTTO E DATI TECNICI / <i>PRODUCT PERFORMANCES AND TECHNICAL DATA</i>	84
H26 - ACCESSORI / <i>ACCESSORIES</i>	85
P26 - APPLICAZIONI / <i>APPLICATIONS</i>	88
P26 - BINARIO DA TERRA STANDALONE / <i>FLOOR STANDING TRACK</i>	89
P26 - CONFIGURATORE CODICE E COMPOSIZIONE MECCANICA / <i>CODE CONFIGURATOR AND MECHANICAL COMPOSITION</i>	90

SENZAFINE

Il prodotto SENZAFINE con la sua luce diffusa è adatto ad essere utilizzato in ambienti hospitality come bar e ristoranti.
SENZAFINE with its diffused light is suitable for use in hospitality applications as bars or restaurants.



SENZAFINE

Grazie alla sua facile installazione nei binari MULTISYSTEM, SENZAFINE è perfetto per essere utilizzato nelle vetrine dei negozi dove l'allestimento cambia molto di frequente.

SENZAFINE thanks to its easy installation into MULTISYSTEM tracks is perfect to be used in retail windows where the setup changes very often.

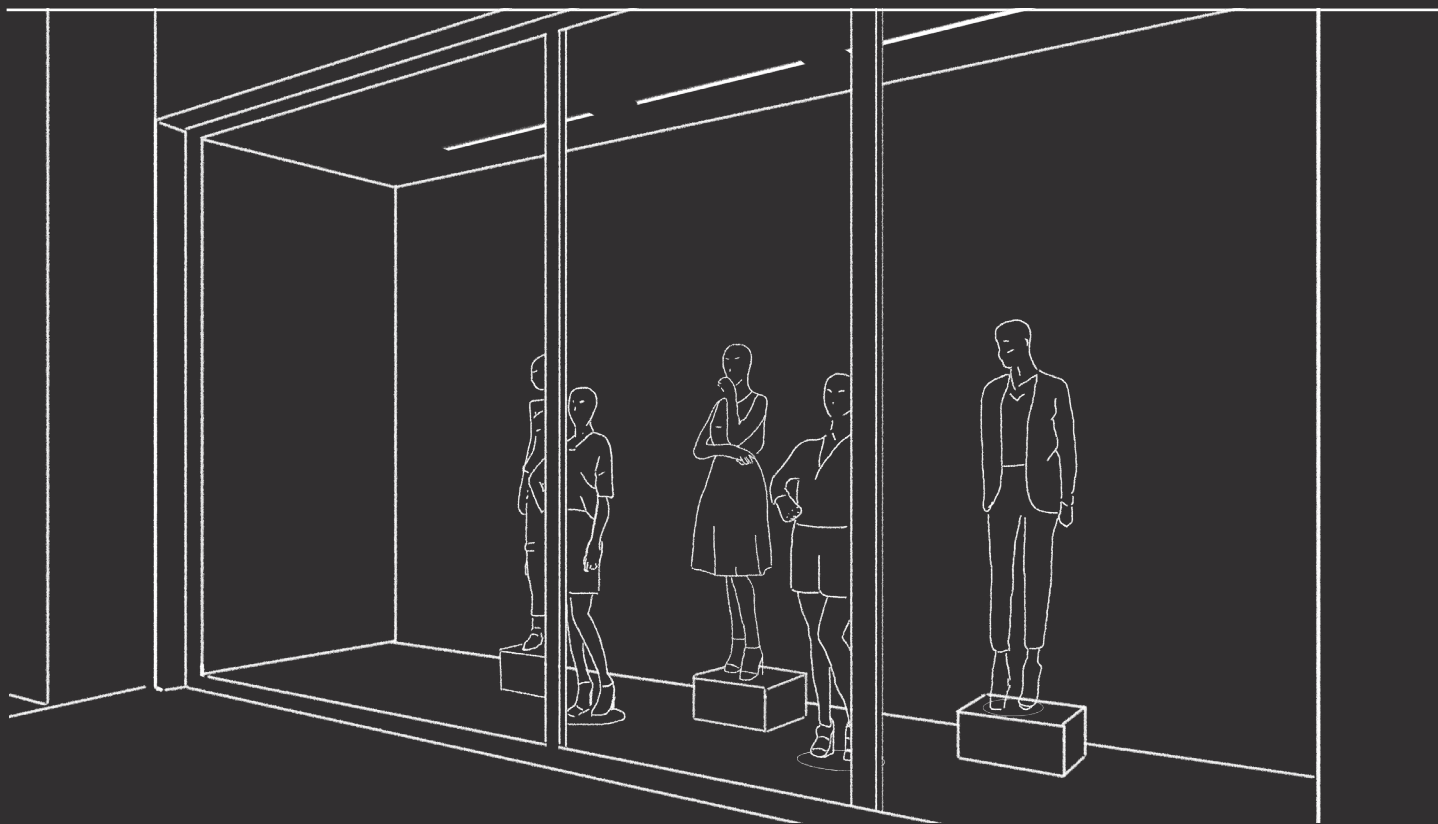

SENZAFINE

GAMMA SENZAFINE

SENZAFINE RANGE

I moduli di luce lineare **SENZAFINE** costituiscono una gamma completa per i tuoi progetti di illuminazione a binario. I moduli sono disponibili in diverse lunghezze ed utilizzano schede LED di alta qualità con un indice di resa cromatica elevato ($CRI \geq 90$ / $CRI \geq 95$), per garantire il massimo comfort visivo. Le versioni con driver DALI SELV possono essere controllate in modo immediato da tablet o mobile grazie alla app A.A.G. Stucchi Light Control, disponibile su App Store. L'installazione è semplice ed immediata, senza l'utilizzo di tools.

SENZAFINE linear light modules constitute a complete range for all track lighting installations. Modules are in different lengths. They use high-quality LED modules with high Colour Rendering Index ($CRI \geq 90$ and $CRI \geq 95$) ensuring the best possible visual comfort. DALI SELV version can be controlled easily through a tablet or mobile device using the A.A.G. Stucchi Light Control App available on App Store. Installation is easy and fast, without tools.



Il prodotto SENZAFINE può essere installato solo su binari 9500 MULTISYSTEM*/MULTISYSTEM* EVO (4 conduttori) della stessa azienda produttrice (esclusi 9500...ST7../9500...ST9... parte superiore).
SENZAFINE may only be used with 9500 MULTISYSTEM*/MULTISYSTEM* EVO tracks (4 conductors) made by the same company (excluding 9500...ST7../9500...ST9... upper side).

LA LUCE GIUSTA NEL PUNTO GIUSTO

THE RIGHT LIGHT AT THE RIGHT PLACE

SENZAFINE si pone come obiettivo quello di essere utilizzato nei più diversi ambiti ed applicazioni di luce a binario. Per questo la gamma dispone di diverse tipologie di prodotto. Lo schermo opalino (disponibile anche in versione fumé) garantisce una luce morbida e diffusa mentre quello microprismatico aumenta l'efficienza luminosa. La versione UGR<19 rende tutto il sistema adatto a quegli ambienti dove è fondamentale evitare l'abbagliamento molesto come ad esempio i luoghi di lavoro, mentre le varie versioni di lenti a disposizione permettono di illuminare con maggiore dettaglio gli oggetti e gli spazi.

SENZAFINE è disponibile anche in versione ADJUSTABLE, per orientare la luce nel modo più corretto e TWIST per creare layout di luce dinamici.

SENZAFINE is intended to be used in various track lighting applications. This is why the range included products with different characteristics. An opal screen (fumé version available) provides diffused light while the microprismatic one spreads the light over a larger surface. The UGR<19 version makes the system suitable to be used where glare must be minimized like in the work place while lenses allow the light to have precise distribution to illuminate objects of defined spaces. SENZAFINE is also ADJUSTABLE, so that you can direct light to one direction or the other depending on the needs and TWIST, to create dynamic light layouts.

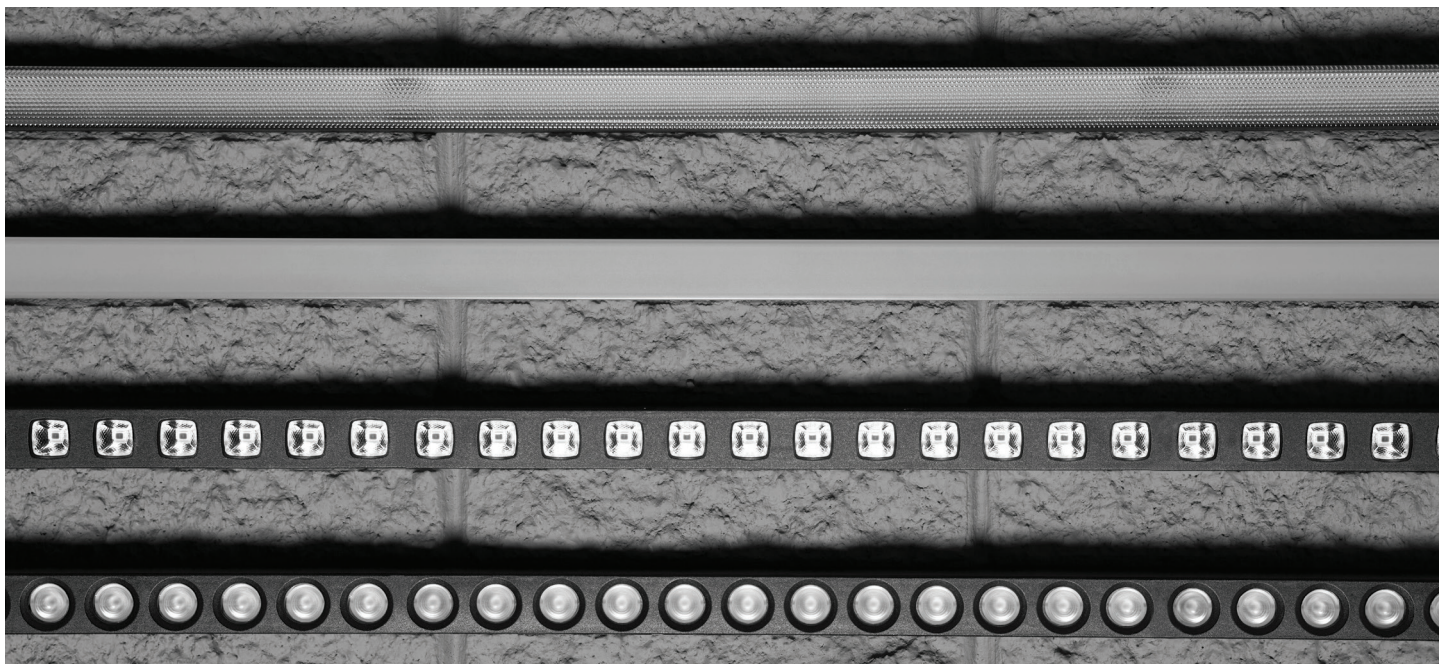

CONFIGURATORE CODICE

CODE CONFIGURATOR

Codice di esempio / Code example

M22286/B5-O-2-E

↓ ↓ ↓ ↓ ↓ ↓ ↓
1 2 3 4 5 6 7

1 - PREFISSO / PREFIX

M22 SENZAFINE

2 - MISURA / LENGTH

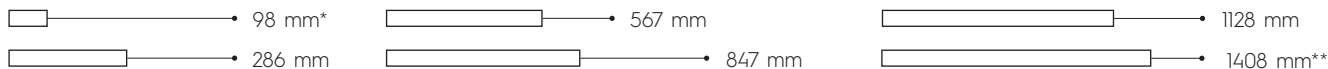

*Solo schermi U e A B E / Only U and A B E screens **Solo schermi O e M / Only O and M screens

3 - COLORE E FINITURA / COLOUR AND FINISHING

B Nero gofrato / Black embossed
RAL 9005

W2 Bianco gofrato / White embossed
RAL 9016

4 - CARATTERISTICHE LUCE / LIGHT FEATURES

1 3000K CRI 90 H **3** 3000K CRI 95 **5** 3000K CRI 90

1 98 e 286 UGR + 98mm Lenti / 98 and 286 UGR and 98 Lens

3 Solo schermi U-A-B-E / Only U-A-B-E screens

5 Solo schermi O e M / Only O and M screens

Altre temperature colore e CRI disponibili su richiesta / Other colour temperatures and CRI available upon request

5 - SCHERMI / SCREENS

O Opalino <i>Opal</i>	M Microprismatico <i>Microprismatic</i>	U UGR	F Fumé*	W Wall Washer
A Lente 20° <i>Lens 20°</i>	B Lente 30° <i>Lens 30°</i>	E Lente ellittica 26°x42° <i>Elliptic lens 26°x42°</i>		

*Non disponibile per apparecchi di colore bianco

*Not available for white products

6 - DRIVER

0 ON - OFF	1 0...10V*	2 DALI SELV	3 ON - OFF PLUS**	4 DALI SELV PLUS**	9 NO DRIVER
-------------------	-------------------	--------------------	--------------------------	---------------------------	--------------------

*Disponibile solo per alcune versioni, richiedi maggiori informazioni

*Available only for some versions, ask for more info

**Solo M22286/...1-U e M22286/...5-W

**Only M22286/...1-U... and M22286/...5-W

7 - SUFFISSO / SUFFIX

-E

ESEMPI / EXAMPLES

M221128/B5-M-2-E

SENZAFINE | L=1128mm | Nero gofrato | 3000K CRI 90 | Microprismatico | DALI SELV
SENZAFINE | L=1128mm | Black embossed | 3000K CRI 90 | Microprismatic | DALI SELV

M221408/B5-O-9-E

SENZAFINE | L=1408mm | Nero gofrato | 3000K CRI 90 | Opal | No Driver
SENZAFINE | L=1408mm | Black embossed | 3000K CRI 90 | Opal | No Driver

COMPOSIZIONE MECCANICA

MECHANICAL COMPOSITION

OPAL/MICRO/FUMÉ

LUNGHEZZE DISPONIBILI (mm) / AVAILABLE LENGTHS (mm)

286 / 567 / 847 / 1128 / 1408

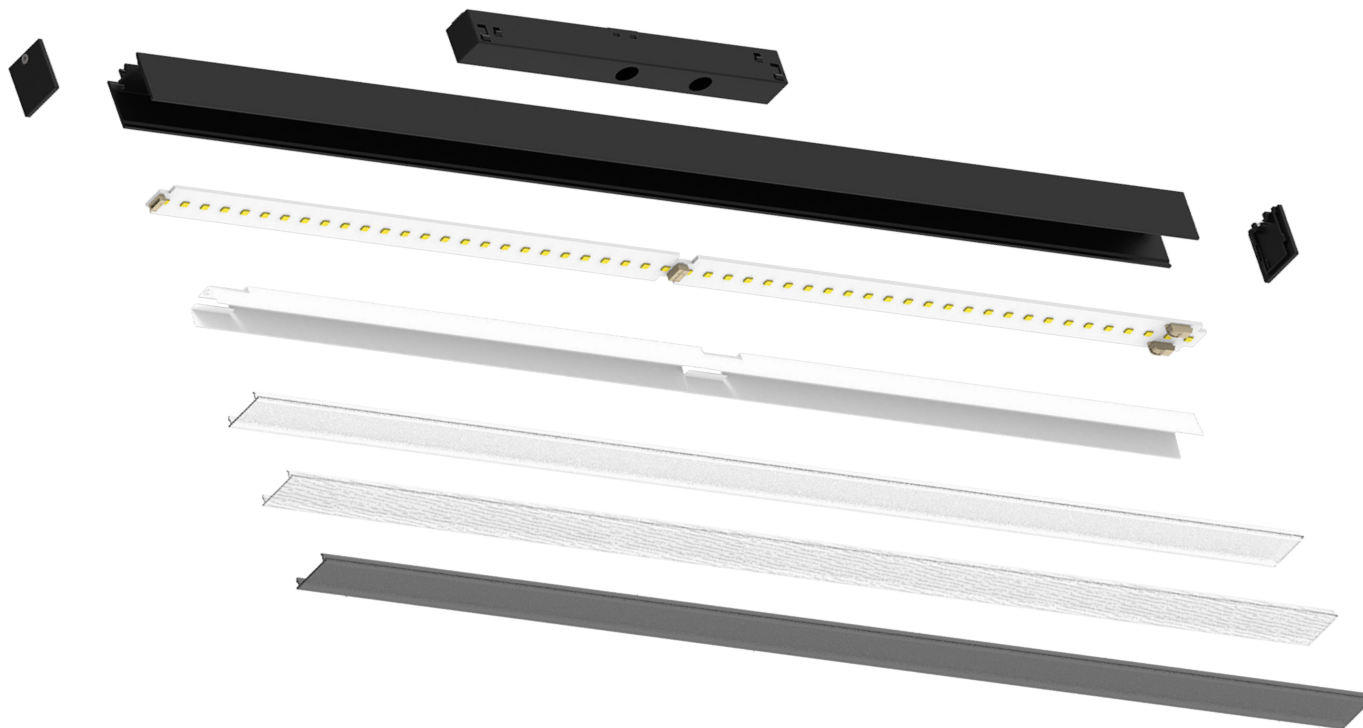

COMPONENTI VENDIBILI SEPARATAMENTE / COMPONENTS CAN BE SOLD SEPARATELY

ACCESSORI

ACCESSORIES



S-9500/...-L1-3000

Profilo estruso
Extruded profile



9504/L1-...

Tappi
End caps



M22-26-...

Scheda LED
LED module



9519-166-M22/...-E

Adattatore
Adapter



9500/MIC

Schermo microprismatico
Microprismatic screen



S-9500/F-3000

Schermo fumé
Fumé screen



S-9500/OPN-3000

Schermo opalino + Recuperatore
Opal screen + Reflector

COMPOSIZIONE MECCANICA

MECHANICAL COMPOSITION

UGR/LENS

LUNGHEZZE DISPONIBILI (mm) / AVAILABLE LENGTHS (mm)

98 / 286 / 567 / 847 / 1128



COMPONENTI VENDIBILI SEPARATAMENTE / COMPONENTS CAN BE SOLD SEPARATELY

ACCESSORI

ACCESSORIES



S-9500/...-L2-3000

Profilo estruso

Extruded profile



9504/L1-...

Tappi

End caps



M22-12-...

Scheda LED

LED module



9519-166-M22/...-E

Adattatore

Adapter

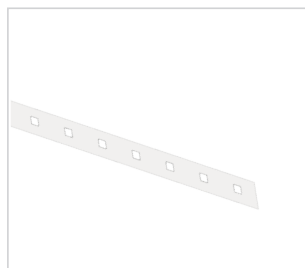

S-M22/F-UGR

Pellicola isolante

Isolating film



M22/O-... + M22/C-L-B

Lenti + Cover

Lenses + Cover



S-M22/O-UGR + S-M22/C-UGR-B

Riflettore UGR + Cover

UGR Reflector + Cover

COMPOSIZIONE MECCANICA

MECHANICAL COMPOSITION

WALL WASHER

LUNGHEZZE DISPONIBILI (mm) / AVAILABLE LENGTHS (mm)

286 / 567



COMPONENTI VENDIBILI SEPARATAMENTE / COMPONENTS CAN BE SOLD SEPARATELY

ACCESSORI ACCESSORIES

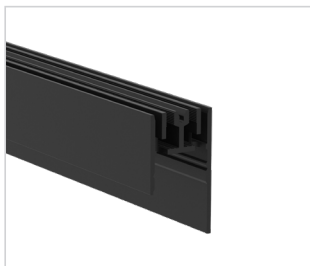

S-9500/...-L4-3000

Profilo estruso
Extruded profile

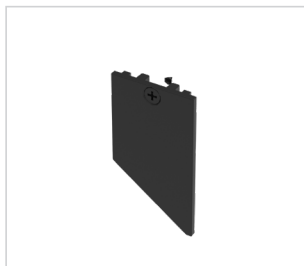

KIT-9504/L4-...

Tappi
End caps



S-LC190280L32B3090D240000

Scheda LED
LED module



9519-166-M22/...-E

Adattatore
Adapter

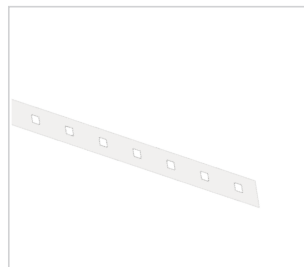

S-M22/F-UGR

Pellicola isolante
Isolating film

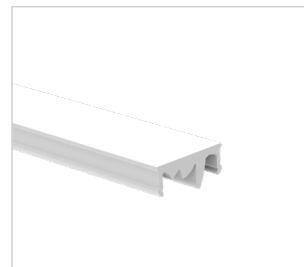

S-9500/WW-3000

Schermo wall washer
Wall washer screen

SENZAFINE OPAL/MICRO/FUMÉ

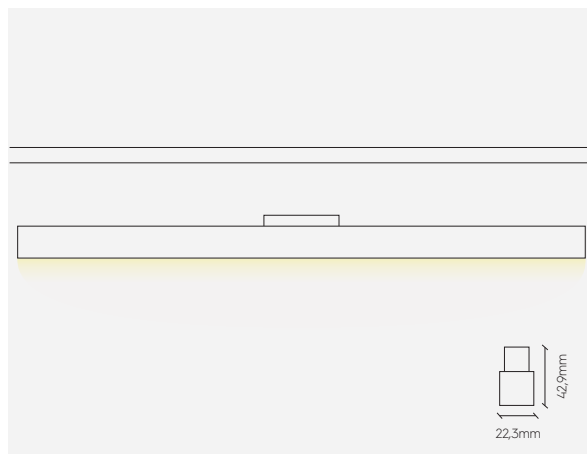
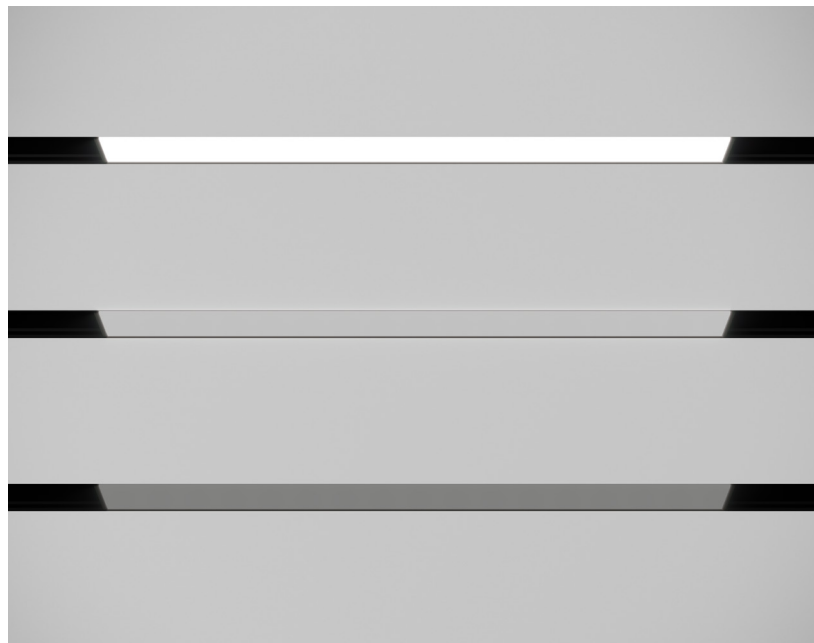

Lunghezze disponibili (mm) / Available lengths (mm)

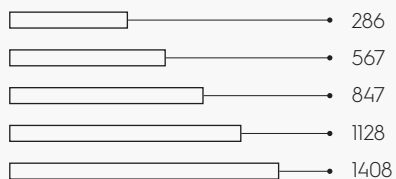

CRI

≥90

Colori disponibili / Available colours



Temperatura colore (K) / Colour temperature (K)

3000

Schermo Opalino
Opal Screen

M22567/B5-O-...

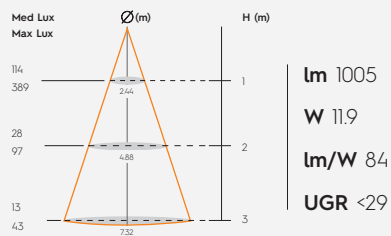
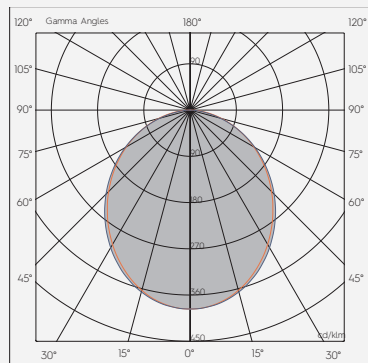

Schermo Microprismatic*
Microprismatic screen*

M22567/B5-M-...

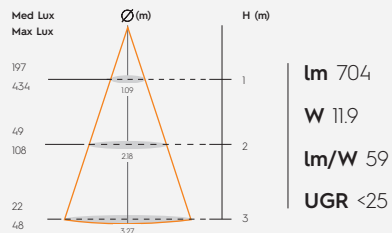
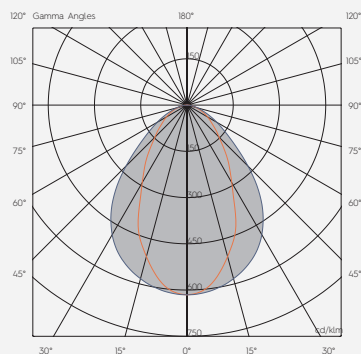

Schermo Fumé**
Fumé Screen**

M22567/B5-F-...

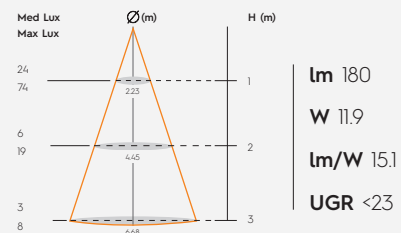
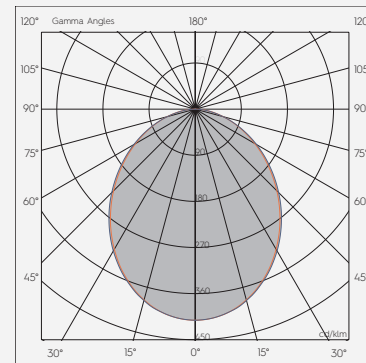

*lm= flusso reale. Dati riferiti ad apparecchi di colore nero. Finitura bianca= +12 % circa sul flusso indicato
*lm= real flux. Datas refer to black colour fixtures. White colour= about +12% on the real flux

**Non disponibile per apparecchi di colore bianco
**Not available for white products

DATI TECNICI RANGE DI PRODOTTO

PRODUCT RANGE TECHNICAL DATA

OPAL

CRI \geq 90

[mm]	n°. LED Mod	[K]	I LED [mA]	FLUSSO NOMINALE [lm] NOMINAL FLUX [lm]	FLUSSO REALE [lm] REAL FLUX [lm]	POTENZA [W] POWER [W]	POTENZA LED [W] POWER LED [W]	V _F	CRI	SDCM	LIFETIME [Khr]
286	1	3000	150	710	494,9	6,1	5,3	~ 36	\geq 90	\leq 3	>50Khr L90B5
567	2	3000	300	1420	989,7	11,4	10,6	~ 36	\geq 90	\leq 3	>50Khr L90B5
847	3	3000	450	2129	1484,6	17,2	15,9	~ 36	\geq 90	\leq 3	>50Khr L90B5
1128	4	3000	600	2839	1979,4	22,9	21,2	~ 36	\geq 90	\leq 3	>50Khr L90B5
1408	5	3000	750	3549	2474,3	28,8	26,5	~ 36	\geq 90	\leq 3	>50Khr L90B5

MICRO

CRI \geq 90

[mm]	n°. LED Mod	[K]	I LED [mA]	FLUSSO NOMINALE [lm] NOMINAL FLUX [lm]	FLUSSO REALE [lm] REAL FLUX [lm]	POTENZA [W] POWER [W]	POTENZA LED [W] POWER LED [W]	V _F	CRI	SDCM	LIFETIME [Khr]
286	1	3000	150	710	347,1	6,1	5,3	~ 36	\geq 90	\leq 3	>50Khr L90B5
567	2	3000	300	1420	694,1	11,4	10,6	~ 36	\geq 90	\leq 3	>50Khr L90B5
847	3	3000	450	2129	1041,2	17,2	15,9	~ 36	\geq 90	\leq 3	>50Khr L90B5
1128	4	3000	600	2839	1388,2	22,9	21,2	~ 36	\geq 90	\leq 3	>50Khr L90B5
1408	5	3000	750	3549	1735,3	28,8	26,5	~ 36	\geq 90	\leq 3	>50Khr L90B5

DATI TECNICI RANGE DI PRODOTTO

PRODUCT RANGE TECHNICAL DATA

FUMÉ

CRI \geq 90

[mm]	n°. LED Mod	[K]	I LED [mA]	FLUSSO NOMINALE [lm] <i>NOMINAL FLUX [lm]</i>	FLUSSO REALE [lm] <i>REAL FLUX [lm]</i>	POTENZA [W] <i>POWER [W]</i>	POTENZA LED [W] <i>POWER LED [W]</i>	V _f	CRI	SDCM	LIFETIME [Khr]
286	1	3000	150	710	90,1	6,1	5,3	~ 36	\geq 90	\leq 3	>50Khr L90B5
567	2	3000	300	1420	180,1	11,4	10,6	~ 36	\geq 90	\leq 3	>50Khr L90B5
847	3	3000	450	2129	270,2	17,2	15,9	~ 36	\geq 90	\leq 3	>50Khr L90B5
1128	4	3000	600	2839	360,2	22,9	21,2	~ 36	\geq 90	\leq 3	>50Khr L90B5
1408	5	3000	750	3549	450,3	28,8	26,5	~ 36	\geq 90	\leq 3	>50Khr L90B5

SENZAFINE UGR<19

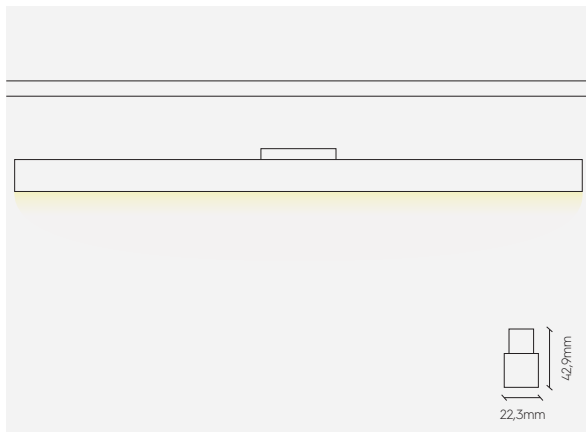
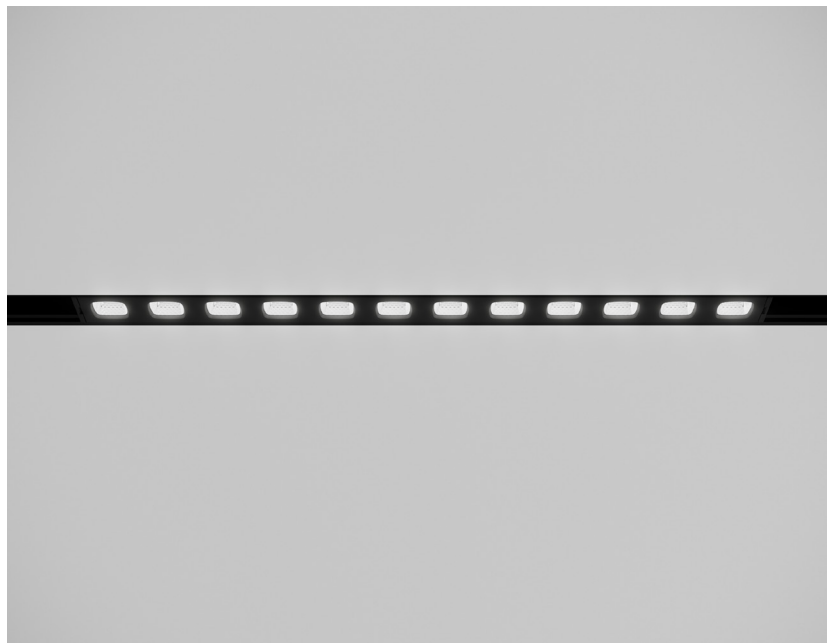

Lunghezze disponibili (mm) / Available lengths (mm)

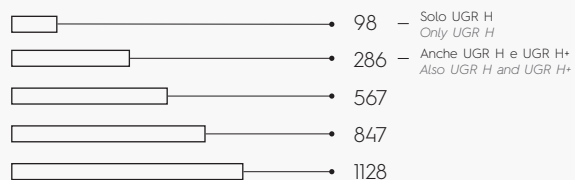

CRI

≥90 Versione H e H+ / H and H+ version
≥95

Colori disponibili / Available colours

-  Nero gofrato / Black embossed
-  Bianco gofrato / White embossed

Temperatura colore (K) / Colour temperature (K)

3000

Driver incluso / Driver included

Ottica UGR
UGR Optic

M22286/B3-U...

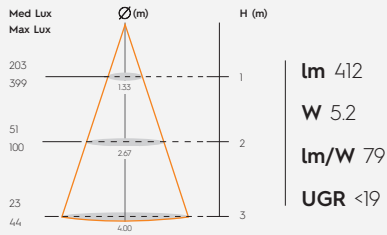
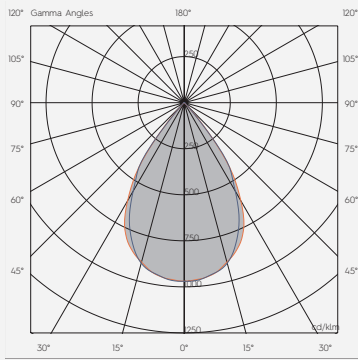

Ottica UGR High Output
UGR High Output Optic

M22286/B1-U...

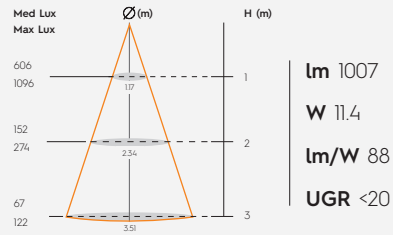
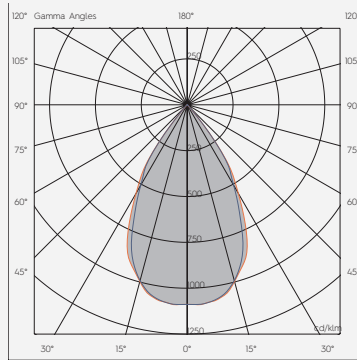

Ottica UGR High Output +
UGR High Output + Optic

M22286/B1-U...

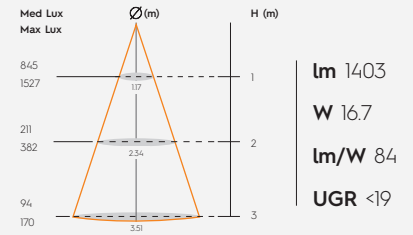
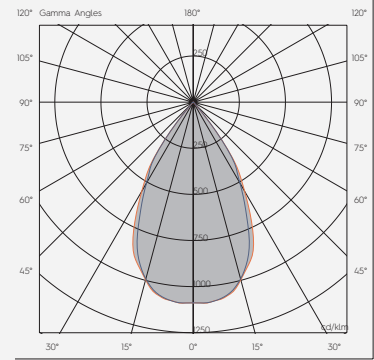

DATI TECNICI RANGE DI PRODOTTO

PRODUCT RANGE TECHNICAL DATA

UGR<19

CRI≥95

[mm]	n°. LED Mod	[K]	I LED [mA]	FLUSSO NOMINALE [lm] NOMINAL FLUX [lm]	FLUSSO REALE [lm] REAL FLUX [lm]	POTENZA [W] POWER [W]	POTENZA LED [W] POWER LED [W]	V _f	CRI	SDCM	LIFETIME [Khr]
286	1	3000	250	504	412,9	5,7	4,2	-18	≥95	≤3	>50Khr L90B10
567	2	3000	500	1009	825,9	10,6	8,4	-18	≥95	≤3	>50Khr L90B10
847	3	3000	750	1513	1238,8	16,1	12,6	-18	≥95	≤3	>50Khr L90B10
1128	4	3000	1000	2017	1651,7	21,2	16,8	-18	≥95	≤3	>50Khr L90B10

UGR<19 HIGH OUTPUT

CRI≥90

[mm]	n°. LED Mod	[K]	I LED [mA]	FLUSSO NOMINALE [lm] NOMINAL FLUX [lm]	FLUSSO REALE [lm] REAL FLUX [lm]	POTENZA [W] POWER [W]	POTENZA LED [W] POWER LED [W]	V _f	CRI	SDCM	LIFETIME [Khr]
98	1	3000	600	709	625,2	8,3	6,9	-12	≥90	≤3	>60Khr L90B10
286	1	3000	300	1146	1010,7	10,3	9,9	-33	≥90	≤3	>60Khr L90B10

Flussi diversi su richiesta / Different flux on demand

DATI TECNICI RANGE DI PRODOTTO

PRODUCT RANGE TECHNICAL DATA

UGR<19 HIGH OUTPUT +

CRI≥90

[mm]	n°. LED Mod	[K]	I LED [mA]	FLUSSO NOMINALE [lm] <i>NOMINAL FLUX [lm]</i>	FLUSSO REALE [lm] <i>REAL FLUX [lm]</i>	POTENZA [W] <i>POWER [W]</i>	POTENZA LED [W] <i>POWER LED [W]</i>	V _f	CRI	SDCM	LIFETIME [Khr]
286	1	3000	450	1654	1458,9	16,6	15,2	~33	≥90	≤3	>60Khr L90B10

SENZAFINE LENS

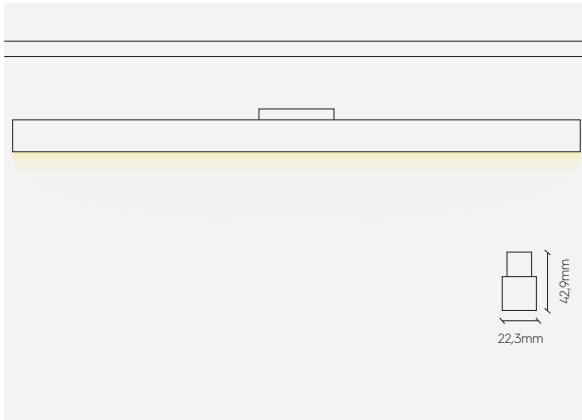
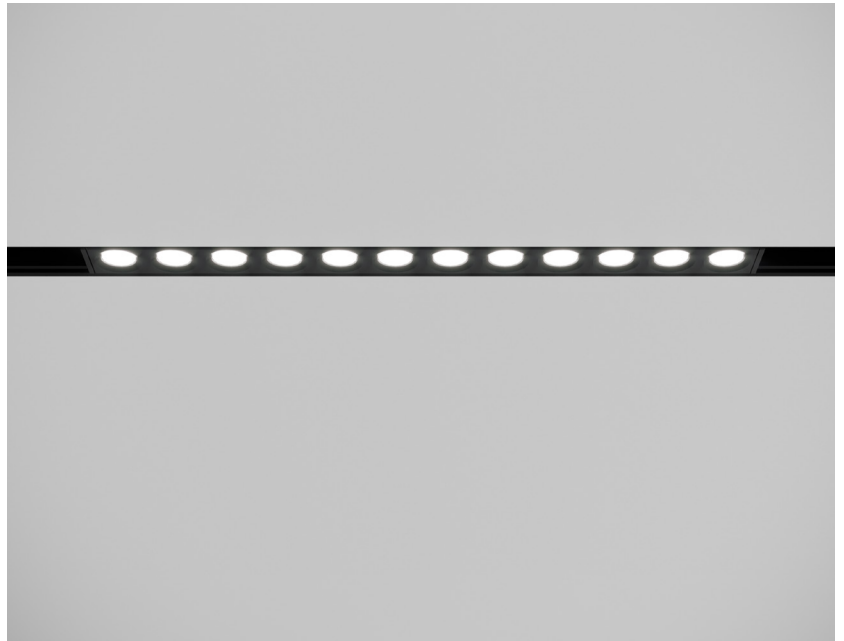

Lunghezze disponibili (mm) / Available lengths (mm)

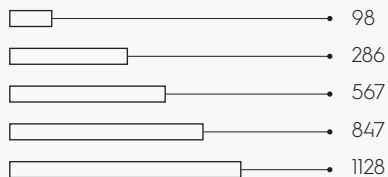

CRI

≥90 - Solo versione H / Only H version
≥95

Colori disponibili / Available colours

-  Nero gofrato / Black embossed
-  Bianco gofrato / White embossed

Temperatura colore (K) / Colour temperature (K)

3000

Lente 20°
Lens 20°

M22847/B3-A...

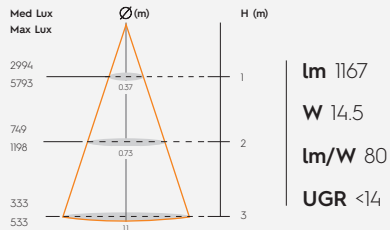
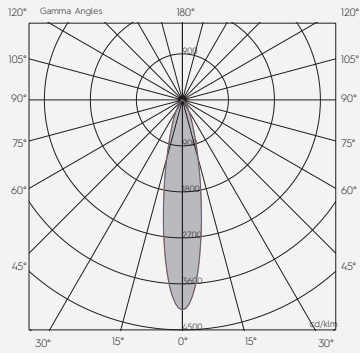

Lente 30°
Lens 30°

M22847/B3-B...

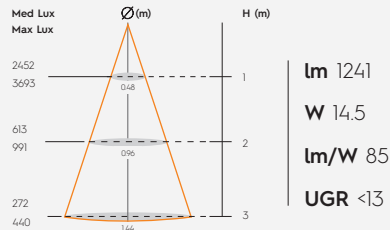
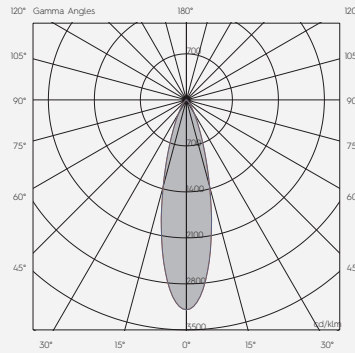

Lente 26°x42°
Lens 26°x42°

M22847/B3-E...

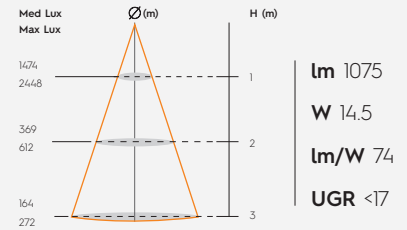
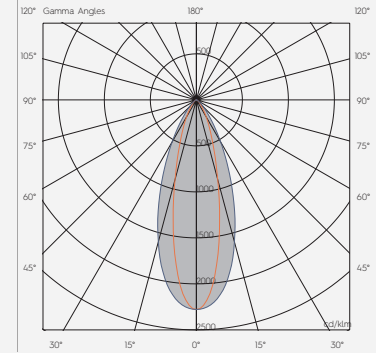

Lente 20° High output
Lens 20° High output

M2298/B1-A...

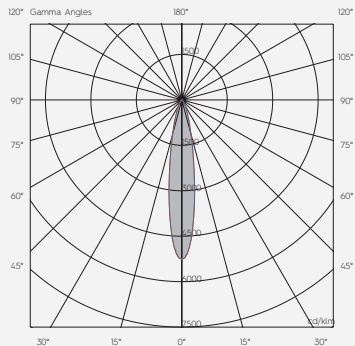

Lente 30° High output
Lens 30° High output

M2298/B1-B...

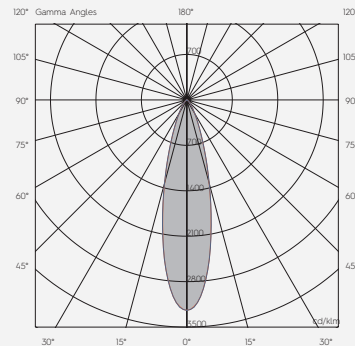

Lente 26°x42° High output
Lens 26°x42° High output

M2298/B1-E...

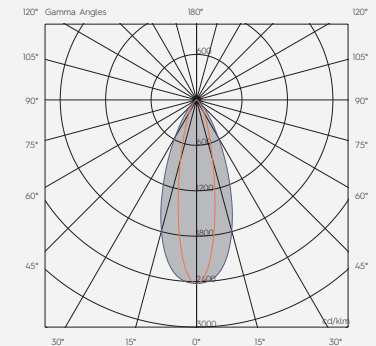

DATI TECNICI RANGE DI PRODOTTO

PRODUCT RANGE TECHNICAL DATA

LENS 20°

CRI≥95

[mm]	n°. LED Mod	[K]	I LED [mA]	FLUSSO NOMINALE [lm] <i>NOMINAL FLUX [lm]</i>	FLUSSO REALE [lm] <i>REAL FLUX [lm]</i>	POTENZA [W] <i>POWER [W]</i>	POTENZA LED [W] <i>POWER LED [W]</i>	V _F	CRI	SDCM	LIFETIME [Khr]
286	1	3000	250	504	388,8	5,7	4,2	-18	≥95	≤3	>50Khr L90B10
567	2	3000	500	1009	777,5	10,6	8,4	-18	≥95	≤3	>50Khr L90B10
847	3	3000	750	1513	1166,3	16,1	12,6	-18	≥95	≤3	>50Khr L90B10
1128	4	3000	1000	2017	1555,1	21,2	16,8	-18	≥95	≤3	>50Khr L90B10

LENS 30°

CRI≥95

[mm]	n°. LED Mod	[K]	I LED [mA]	FLUSSO NOMINALE [lm] <i>NOMINAL FLUX [lm]</i>	FLUSSO REALE [lm] <i>REAL FLUX [lm]</i>	POTENZA [W] <i>POWER [W]</i>	POTENZA LED [W] <i>POWER LED [W]</i>	V _F	CRI	SDCM	LIFETIME [Khr]
286	1	3000	250	504	413,8	5,7	4,2	-18	≥95	≤3	>50Khr L90B10
567	2	3000	500	1009	827,7	10,6	8,4	-18	≥95	≤3	>50Khr L90B10
847	3	3000	750	1513	1241,5	16,1	12,6	-18	≥95	≤3	>50Khr L90B10
1128	4	3000	1000	2017	1655,3	21,2	16,8	-18	≥95	≤3	>50Khr L90B10

DATI TECNICI RANGE DI PRODOTTO

PRODUCT RANGE TECHNICAL DATA

LENS 26x42°

CRI≥95

[mm]	n°. LED Mod	[K]	I LED [mA]	FLUSSO NOMINALE [lm] <i>NOMINAL FLUX [lm]</i>	FLUSSO REALE [lm] <i>REAL FLUX [lm]</i>	POTENZA [W] <i>POWER [W]</i>	POTENZA LED [W] <i>POWER LED [W]</i>	V _F	CRI	SDCM	LIFETIME [Khr]
286	1	3000	250	504	358,3	5,7	4,2	-18	≥95	≤3	>50Khr L90B10
567	2	3000	500	1009	716,6	10,6	8,4	-18	≥95	≤3	>50Khr L90B10
847	3	3000	750	1513	1074,8	16,1	12,6	-18	≥95	≤3	>50Khr L90B10
1128	4	3000	1000	2017	1433,1	21,2	16,8	-18	≥95	≤3	>50Khr L90B10

DATI TECNICI RANGE DI PRODOTTO

PRODUCT RANGE TECHNICAL DATA

LENS 20° HIGH OUTPUT

CRI≥90

[mm]	n°. LED Mod	[K]	I LED [mA]	FLUSSO NOMINALE [lm] <i>NOMINAL FLUX [lm]</i>	FLUSSO REALE [lm] <i>REAL FLUX [lm]</i>	POTENZA [W] <i>POWER [W]</i>	POTENZA LED [W] <i>POWER LED [W]</i>	V _f	CRI	SDCM	LIFETIME [Khr]
98	1	3000	600	709	549	8,3	6,9	-12	≥90	≤3	>60Khr L90B10

LENS 30° HIGH OUTPUT

CRI≥90

[mm]	n°. LED Mod	[K]	I LED [mA]	FLUSSO NOMINALE [lm] <i>NOMINAL FLUX [lm]</i>	FLUSSO REALE [lm] <i>REAL FLUX [lm]</i>	POTENZA [W] <i>POWER [W]</i>	POTENZA LED [W] <i>POWER LED [W]</i>	V _f	CRI	SDCM	LIFETIME [Khr]
98	1	3000	600	709	528,4	8,3	6,9	-12	≥90	≤3	>60Khr L90B10

LENS 26x42° HIGH OUTPUT

CRI≥90

[mm]	n°. LED Mod	[K]	I LED [mA]	FLUSSO NOMINALE [lm] <i>NOMINAL FLUX [lm]</i>	FLUSSO REALE [lm] <i>REAL FLUX [lm]</i>	POTENZA [W] <i>POWER [W]</i>	POTENZA LED [W] <i>POWER LED [W]</i>	V _f	CRI	SDCM	LIFETIME [Khr]
98	1	3000	600	709	501,1	8,3	6,9	-12	≥90	≤3	>60Khr L90B10

SENZAFINE WALL WASHER

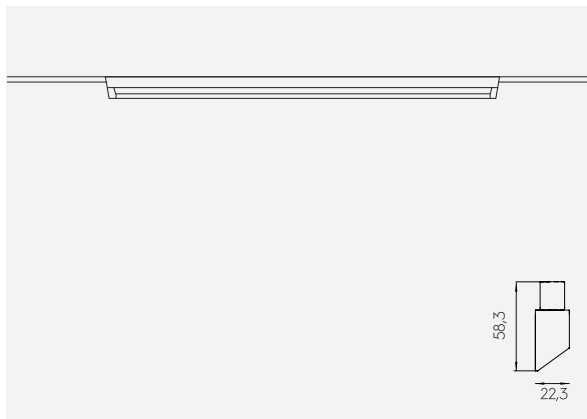

Lunghezze disponibili (mm) / Available lengths (mm)

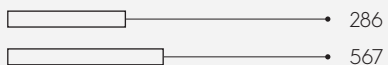

CRI

≥90

Colori disponibili / Available colours



Temperatura colore (K) / Colour temperature (K)

3000

Schermo Wall washer
Wall washer screen

M22286/B5-W-...

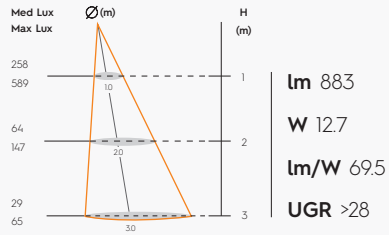
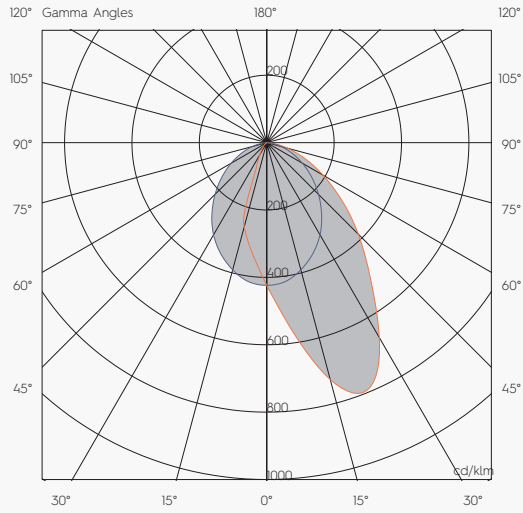

Schermo Wall washer PLUS
Wall washer PLUS screen

M22286/B5-W-...

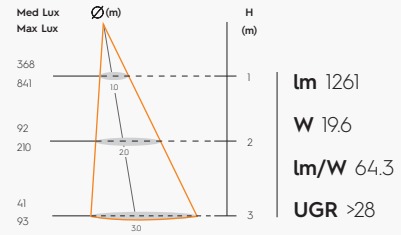
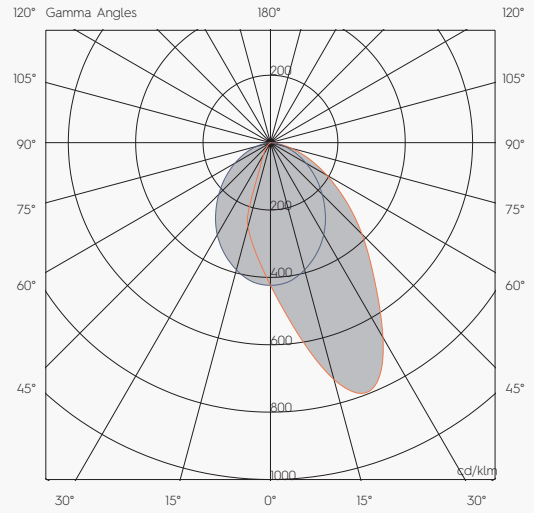

DATI TECNICI RANGE DI PRODOTTO

PRODUCT RANGE TECHNICAL DATA

WALL WASHER

[mm]	n°. LED Mod	[K]	I LED [mA]	FLUSSO NOMINALE [lm] <i>NOMINAL FLUX [lm]</i>	FLUSSO REALE [lm] <i>REAL FLUX [lm]</i>	POTENZA [W] <i>POWER [W]</i>	POTENZA LED [W] <i>POWER LED [W]</i>	V _f	CRI	SDCM	LIFETIME [Khr]
286	1	3000	500	1398,4	883,1	12,7	11,4	~ 25	≥90	≤3	>50Khr L90B5
567	2	3000	1000	2796,8	1766,2	25,3	22,8	~ 25	≥90	≤3	>50Khr L90B5

WALL WASHER PLUS

[mm]	n°. LED Mod	[K]	I LED [mA]	FLUSSO NOMINALE [lm] <i>NOMINAL FLUX [lm]</i>	FLUSSO REALE [lm] <i>REAL FLUX [lm]</i>	POTENZA [W] <i>POWER [W]</i>	POTENZA LED [W] <i>POWER LED [W]</i>	V _f	CRI	SDCM	LIFETIME [Khr]
286	1	3000	750	1996,8	1261,0	19,6	17,6	~ 26	≥90	≤3	>50Khr L90B5

SENZAFINE CROSS

È disponibile con la stessa varietà di ottiche della gamma SENZAFINE ed in diverse lunghezze a seconda dello schermo scelto. L'installazione è pratica e veloce, senza l'utilizzo di tools aggiuntivi.

It is available with the same optic as the SENZAFINE range and in different lengths depending on the screen. Installation is easy and quick with no extra tools.

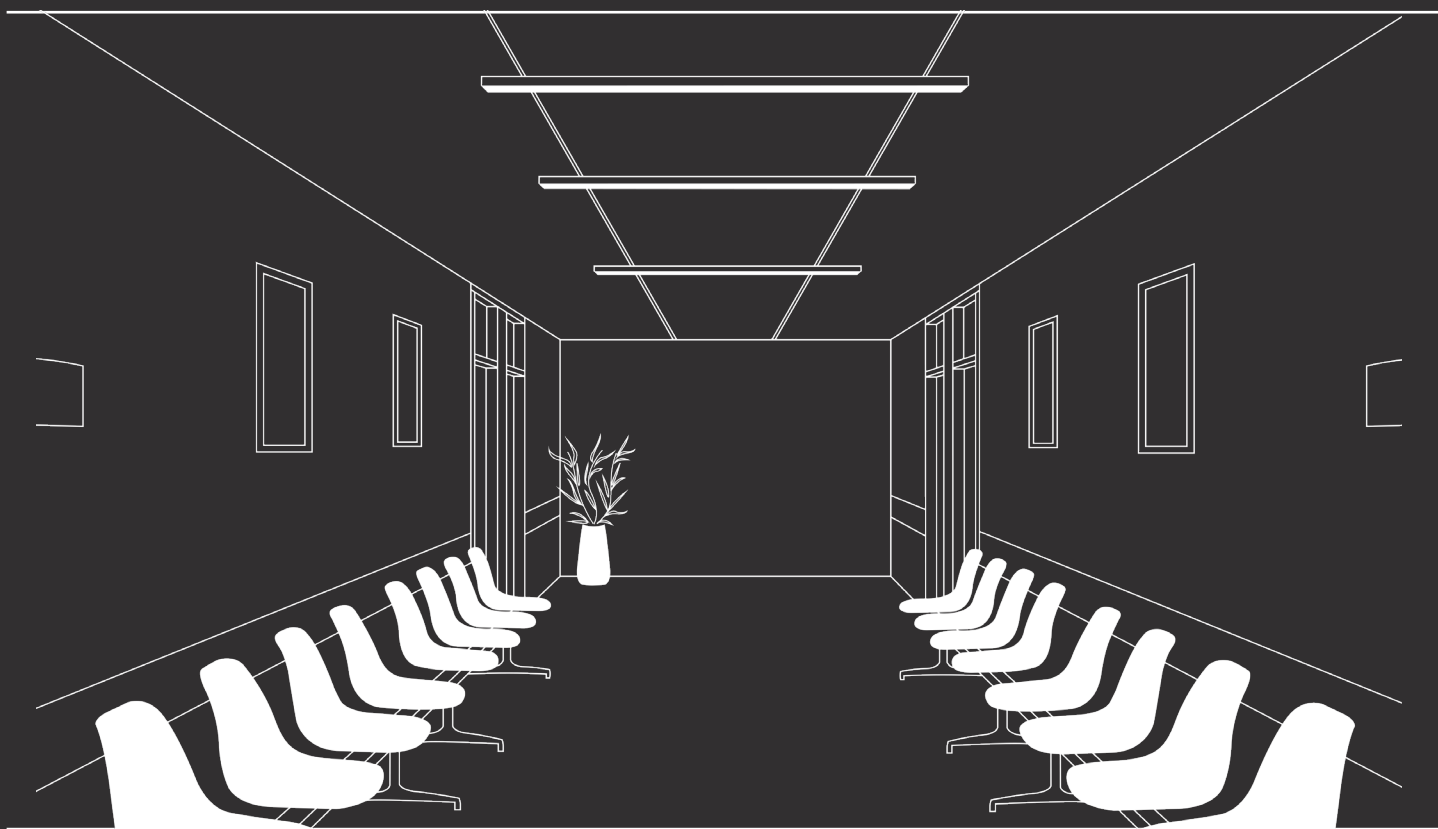

SENZAFINE CROSS

CONFIGURATORE CODICE

CODE CONFIGURATOR

Codice di esempio / Code example

M22C1128/B5-O-2-E

↓ ↓ ↓ ↓ ↓ ↓ ↓
1 2 3 4 5 6 7

1 - PREFISSO / PREFIX

M22C SENZAFINE CROSS

2 - MISURA / LENGTH



*Solo schermi O, M ed F / Only O, M and F screens

3 - COLORE E FINITURA / COLOUR AND FINISHING

B Nero gofrato / Black embossed
RAL 9005

W2 Bianco gofrato / White embossed
RAL 9016

4 - CARATTERISTICHE LUCE / LIGHT FEATURES

3 3000K CRI 95

5 3000K CRI 90

Altre temperature colore e CRI disponibili su richiesta / Other colour temperatures and CRI available upon request

5 - SCHERMI / SCREENS

O Opalino $T_L = 56\%$ <i>Opal $T_L = 56\%$</i>	M Microprismatic <i>Microprismatic</i>	U UGR	F Fumé*
A Lente 20° <i>Lens 20°</i>	B Lente 30° <i>Lens 30°</i>	E Lente ellittica 26°x42° <i>Elliptic lens 26°x42°</i>	

*Non disponibile per apparecchi di colore bianco / *Not available for white products*

6 - DRIVER

0 ON - OFF	1 0...10V	2 DALI SELV	9 NO DRIVER
-------------------	------------------	--------------------	--------------------

7 - DISTANZIALE / SPACER

-E	-E1	-E2
-----------	------------	------------

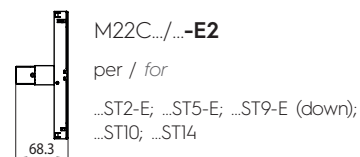
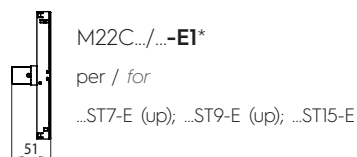
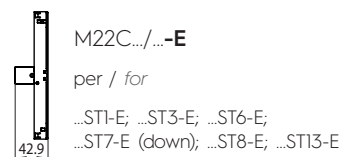

*Non disponibile per schermi UGR / *Not available for UGR screens*

ESEMPI / EXAMPLES

M22C1128/B5-M-2-E

SENZAFINE | L=1128mm | Nero gofrato | 3000K CRI 90 | Microprismatico | DALI SELV
SENZAFINE L=1128mm | Black embossed | 3000K CRI 90 | Microprismatic | DALI SELV

M221408/W25-O-9-E2

SENZAFINE | L=1408mm | Bianco gofrato | 3000K CRI 90 | Opal | No Driver
SENZAFINE L=1408mm | White embossed | 3000K CRI 90 | Opal | No Driver

SENZAFINE CROSS OPAL/MICRO/FUMÉ

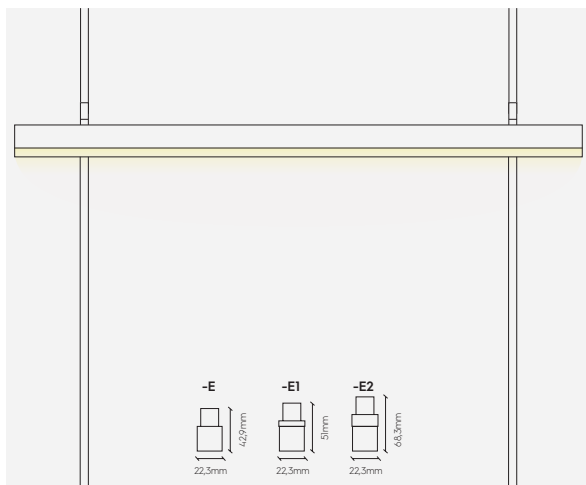
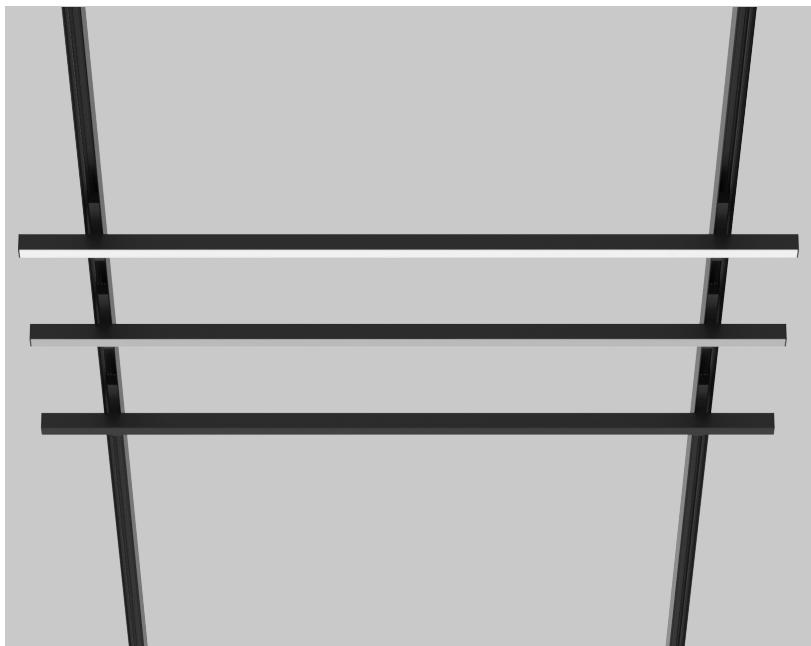

Lunghezze disponibili (mm) / Available lengths (mm)

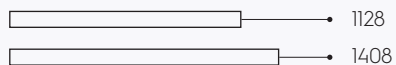

Temperatura colore (K) / Colour temperature (K)

3000

Colori disponibili / Available colours

 Nero gofrato / Black embossed

 Bianco gofrato / White embossed

CRI

≥90

Schermo Opalino
Opal Screen

M221128/B5-O-...

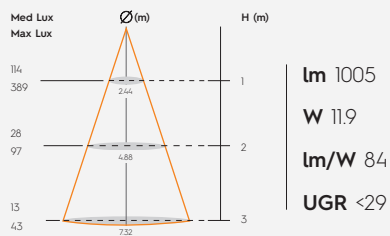
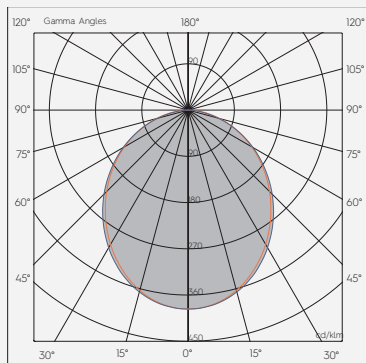

Schermo Microprismatic*
Microprismatic screen*

M221128/B5-M-...

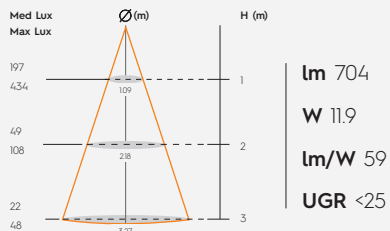
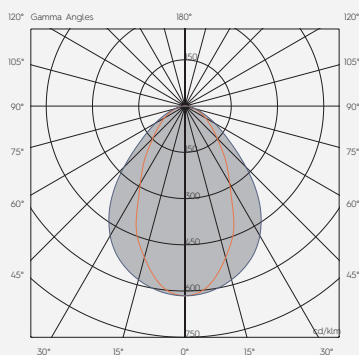

Schermo Fumé**
Fumé Screen**

M221128/B5-F-...

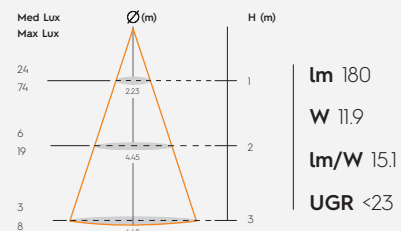
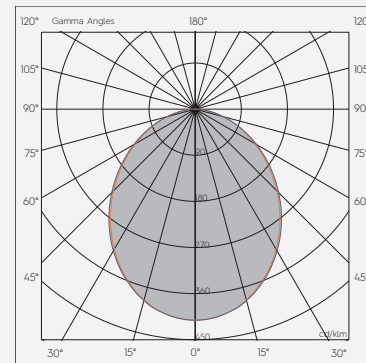

*lm= flusso reale. Dati riferiti ad apparecchi di colore nero. Finitura bianca= +12 % circa sul flusso indicato
*lm= real flux. Datas refer to black colour fixtures. White colour= about +12% on the real flux

**Non disponibile per apparecchi di colore bianco
**Not available for white products

DATI TECNICI RANGE DI PRODOTTO

PRODUCT RANGE TECHNICAL DATA

OPAL

[mm]	n°. LED Mod	[K]	I LED [mA]	FLUSSO NOMINALE [lm] NOMINAL FLUX [lm]	FLUSSO REALE [lm] REAL FLUX [lm]	POTENZA [W] POWER [W]	POTENZA LED [W] POWER LED [W]	V _f	CRI	SDCM	LIFETIME [Khr]
1128	4	3000	600	2839	1979,4	22,9	21,2	-36	≥90	≤3	>50Khr L90B5
1408	5	3000	750	3549	2474,3	28,8	26,5	-36	≥90	≤3	>50Khr L90B5

MICROPRISMATIC

[mm]	n°. LED Mod	[K]	I LED [mA]	FLUSSO NOMINALE [lm] NOMINAL FLUX [lm]	FLUSSO REALE [lm] REAL FLUX [lm]	POTENZA [W] POWER [W]	POTENZA LED [W] POWER LED [W]	V _f	CRI	SDCM	LIFETIME [Khr]
1128	4	3000	600	2839	1388,2	22,9	21,2	-36	≥90	≤3	>50Khr L90B5
1408	5	3000	750	3549	1735,3	28,8	26,5	-36	≥90	≤3	>50Khr L90B5

FUMÉ

[mm]	n°. LED Mod	[K]	I LED [mA]	FLUSSO NOMINALE [lm] NOMINAL FLUX [lm]	FLUSSO REALE [lm] REAL FLUX [lm]	POTENZA [W] POWER [W]	POTENZA LED [W] POWER LED [W]	V _f	CRI	SDCM	LIFETIME [Khr]
1128	4	3000	600	2839	360,2	22,9	21,2	-36	≥90	≤3	>50Khr L90B5
1408	5	3000	750	3549	450,3	28,8	26,5	-36	≥90	≤3	>50Khr L90B5

SENZAFINE CROSS UGR

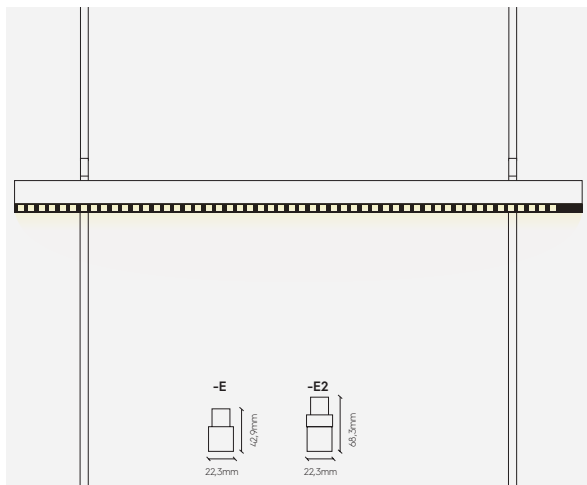
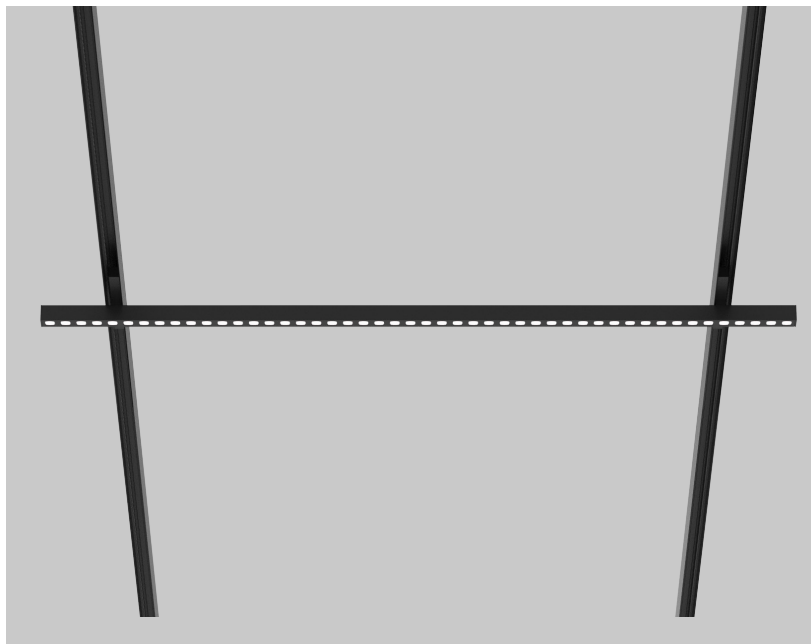

48V

IP20

RG1
at 1m



Lunghezze disponibili (mm) / Available lengths (mm)

1128

Colori disponibili / Available colours

■ Nero gofrato / Black embossed

□ Bianco gofrato / White embossed

Temperatura colore (K) / Colour temperature (K)

3000

CRI

≥95 R9>80

SENZAFINE CROSS LENS

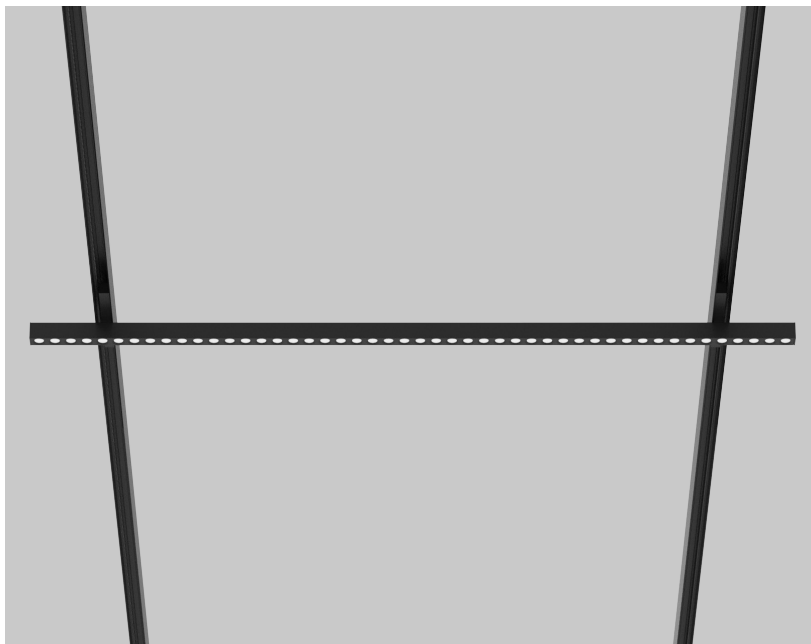
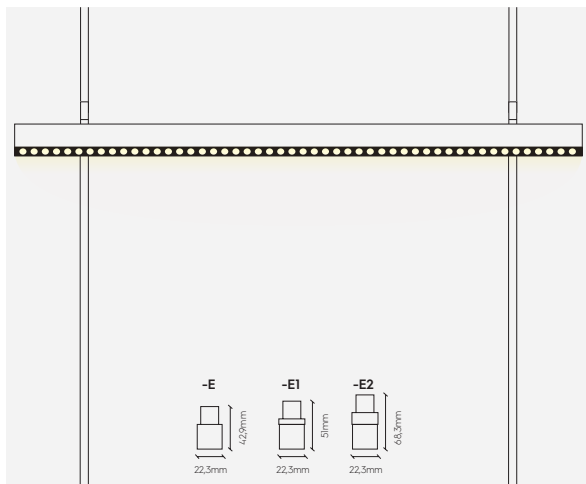

48V

IP20

RGO
at 1,2m



Lunghezze disponibili (mm) / Available lengths (mm)

1128

Colori disponibili / Available colours

■ Nero gofrato / Black embossed

□ Bianco gofrato / White embossed

Temperatura colore (K) / Colour temperature (K)

3000

CRI

≥95 R9>80

DATI TECNICI RANGE DI PRODOTTO

PRODUCT RANGE TECHNICAL DATA

LENS 20°

CRI≥95 R9>80

[mm]	n°. LED Mod	[K]	I LED [mA]	FLUSSO NOMINALE [lm] NOMINAL FLUX [lm]	FLUSSO REALE [lm] REAL FLUX [lm]	POTENZA [W] POWER [W]	POTENZA LED [W] POWER LED [W]	V _f	CRI	SDCM	LIFETIME [Khr]
1128	4	3000	1000	2017	1555,1	21,2	16,8	-18	≥95 R9>80	≤3	>50Khr L90B10

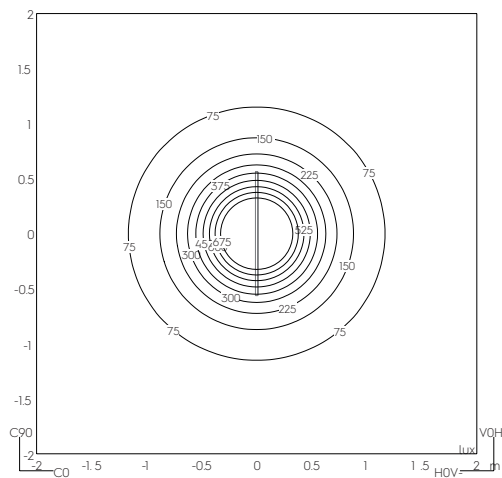
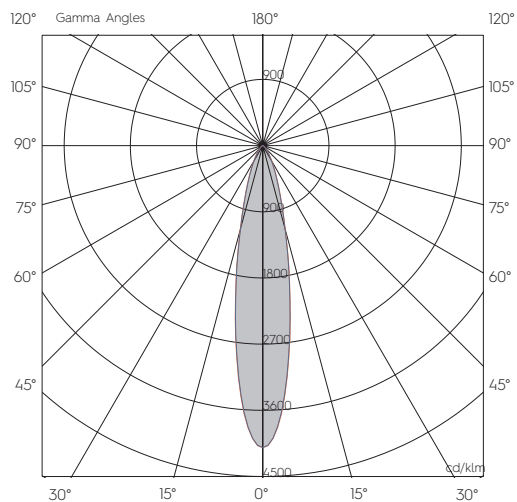

DATI TECNICI RANGE DI PRODOTTO

PRODUCT RANGE TECHNICAL DATA

LENS 30°

CRI≥95 R9>80

[mm]	n°. LED Mod	[K]	I LED [mA]	FLUSSO NOMINALE [lm] NOMINAL FLUX [lm]	FLUSSO REALE [lm] REAL FLUX [lm]	POTENZA [W] POWER [W]	POTENZA LED [W] POWER LED [W]	V _F	CRI	SDCM	LIFETIME [Khr]
1128	4	3000	1000	2017	1655,1	21,2	16,8	-18	≥95 R9>80	≤3	>50Khr L90B10

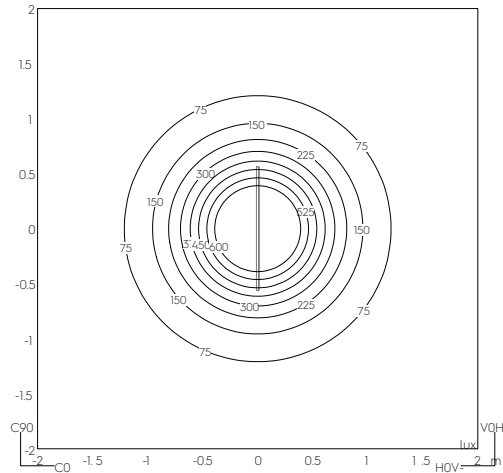
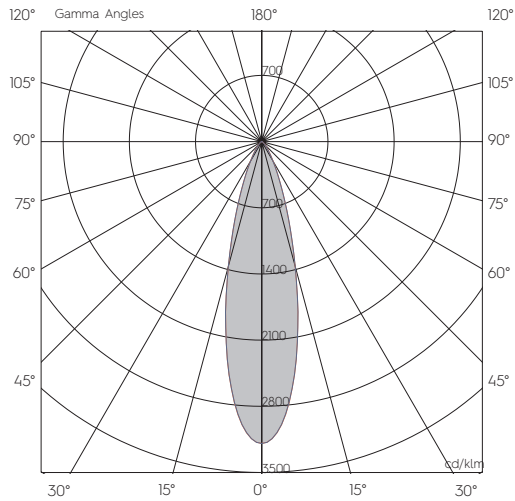

Room (m): 4x4x3m H luminaire (m): 2,5 Ref. surface: floor

DATI TECNICI RANGE DI PRODOTTO

PRODUCT RANGE TECHNICAL DATA

LENS 26°X42°

CRI≥95 R9>80

[mm]	n°. LED Mod	[K]	I LED [mA]	FLUSSO NOMINALE [lm] NOMINAL FLUX [lm]	FLUSSO REALE [lm] REAL FLUX [lm]	POTENZA [W] POWER [W]	POTENZA LED [W] POWER LED [W]	V _f	CRI	SDCM	LIFETIME [Khr]
1128	4	3000	1000	2017	1433,1	21,2	16,8	-18	≥95 R9>80	≤3	>50Khr L90B10

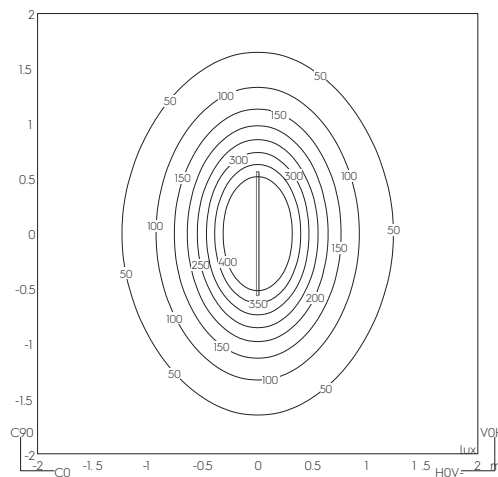
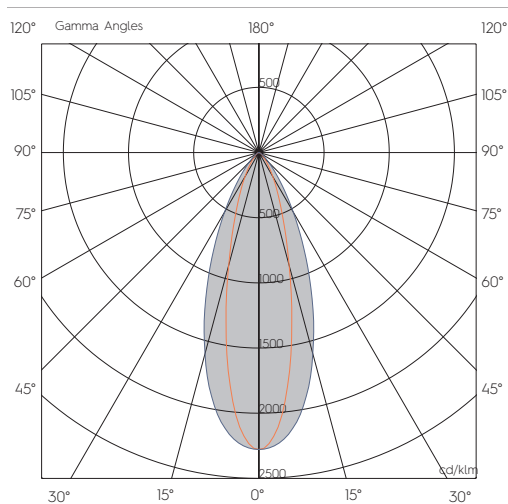

Room (m): 4x4x3h H luminaire (m): 2,5 Ref. surface: floor

SENZAFINE ADJUSTABLE

SENZAFINE nelle sue versioni adjustable permette di orientare la luce per mettere in risalto oggetti di volta in volta diversi.
SENZAFINE adjustable is used to bring out different objects by directing light on them.

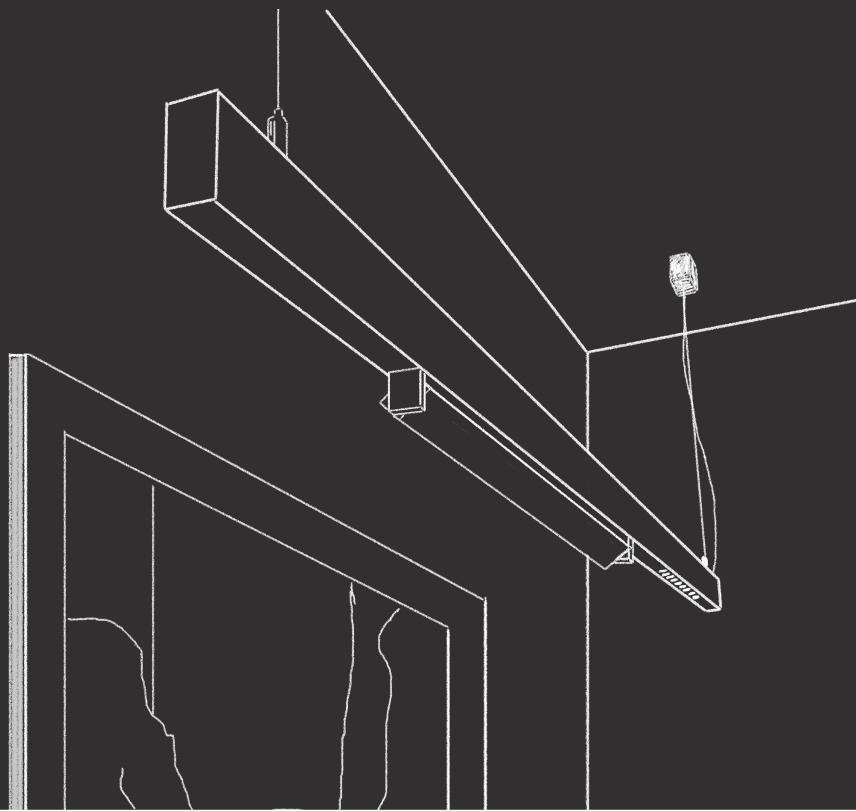

SENZAFINE ADJUSTABLE

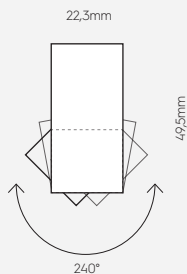

Lunghezze disponibili (mm) / Available lengths (mm)

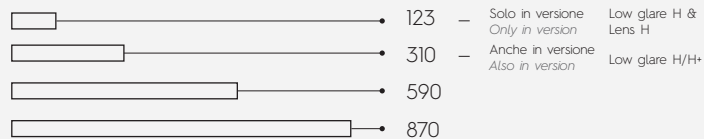

CRI

≥90 - Solo versione / Only version Low glare H & Lens H
≥95

Ottiche / Optics

Opalino / Opal | Microprismatico / Microprismatic | Lenti / Lens | Low glare | Fumé*

Colori disponibili / Available colours

 Nero gofrato / Black embossed

 Bianco gofrato / White embossed

Temperatura colore (K) / Colour temperature (K)

3000

*Non disponibile per apparecchi di colore bianco / *Not available for white products

CONFIGURATORE CODICE

CODE CONFIGURATOR

Codice di esempio / Code example

M22A590/B5-M-2-E

1 2 3 4 5 6 7

1 - PREFISSO / PREFIX

M22A SENZAFINE ADJUSTABLE

2 - MISURA / LENGTH

123 mm* 590 mm
310 mm** 870 mm

*Solo Low glare H e Lenti A - B - E / Only Low glare H and A - B - E Lens **Anche in versione H+ con schermo U / H+ version available with U screen

3 - COLORE E FINITURA / COLOUR AND FINISHING

B Nero gofrato / Black embossed
RAL 9005

W2 Bianco gofrato / White embossed
RAL 9016

4 - CARATTERISTICHE LUCE / LIGHT FEATURES

1 3000K CRI 95 H **3** 3000K CRI 95 **5** 3000K CRI 90

1 123 e 310 UGR + 123mm Low Glare / 123 and 286 UGR and 123 Low glare **3** Solo schermi U-A-B-E / Only U-A-B-E screens **5** Solo schermi O e M / Only O and M screens

Altre temperature colore e CRI disponibili su richiesta
Other colour temperatures and CRI available upon request

5 - SCHERMI / SCREENS

O Opalino $T_L = 56\%$ <i>Opal $T_L = 56\%$</i>	M Microprismatic <i>Microprismatic</i>	U Low glare	F Fumé*
A Lente 20° <i>Lens 20°</i>	B Lente 30° <i>Lens 30°</i>	E Lente ellittica 26°x42° <i>Elliptic lens 26°x42°</i>	

*Non disponibile per apparecchi di colore bianco

**Not available for white products*

6 - DRIVER

0 ON-OFF	1 0..10*V	2 DALI SELV	9 NO DRIVER
-----------------	------------------	--------------------	--------------------

*Non disponibile per queste versioni M22A310/...-O-... M22A590/...-O-... M22A870/...-U-... M22A870/...-B-...
**Not available for these versions M22A310/...-M-... M22A590/...-M-... M22A870/...-A-... M22A870/...-E-...*

7 - SUFFISSO / SUFFIX

-E

ESEMPI / EXAMPLES

M22A590/B5-M-2-E

SENZAFINE ADJUSTABLE | L=590mm | Nero gofrato | 3000K CRI 90 | Microprismatic | DALI SELV
SENZAFINE ADJUSTABLE | L=590mm | Black embossed | 3000K CRI 90 | Microprismatic | DALI SELV

M22A123/B1-U-9-E

SENZAFINE | L=1408mm | Nero gofrato | 3000K CRI 90 | Opal | No Driver
SENZAFINE | L=1408mm | Black embossed | 3000K CRI 90 | Opal | No Driver

DATI TECNICI RANGE DI PRODOTTO

PRODUCT RANGE TECHNICAL DATA

OPAL

CRI \geq 90

[mm]	n°. LED Mod	[K]	I LED [mA]	FLUSSO NOMINALE [lm] NOMINAL FLUX [lm]	FLUSSO REALE [lm] REAL FLUX [lm]	POTENZA [W] POWER [W]	POTENZA LED [W] POWER LED [W]	V _f	CRI	SDCM [w]	LIFETIME [Khr]
310	1	3000	150	710	494,9	6,1	5,3	~ 36	\geq 90	\leq 3	>50Khr L90B5
590	2	3000	300	1420	989,7	11,4	10,6	~ 36	\geq 90	\leq 3	>50Khr L90B5
870	3	3000	450	2129	1484,6	17,2	15,9	~ 36	\geq 90	\leq 3	>50Khr L90B5

FUMÈ

CRI \geq 90

[mm]	n°. LED Mod	[K]	I LED [mA]	FLUSSO NOMINALE [lm] NOMINAL FLUX [lm]	FLUSSO REALE [lm] REAL FLUX [lm]	POTENZA [W] POWER [W]	POTENZA LED [W] POWER LED [W]	V _f	CRI	SDCM	LIFETIME [Khr]
310	1	3000	150	710	90,1	6,1	5,3	~ 36	\geq 90	\leq 3	>50Khr L90B5
590	2	3000	300	1420	180,1	11,4	10,6	~ 36	\geq 90	\leq 3	>50Khr L90B5
870	3	3000	450	2129	270,2	17,2	15,9	~ 36	\geq 90	\leq 3	>50Khr L90B5

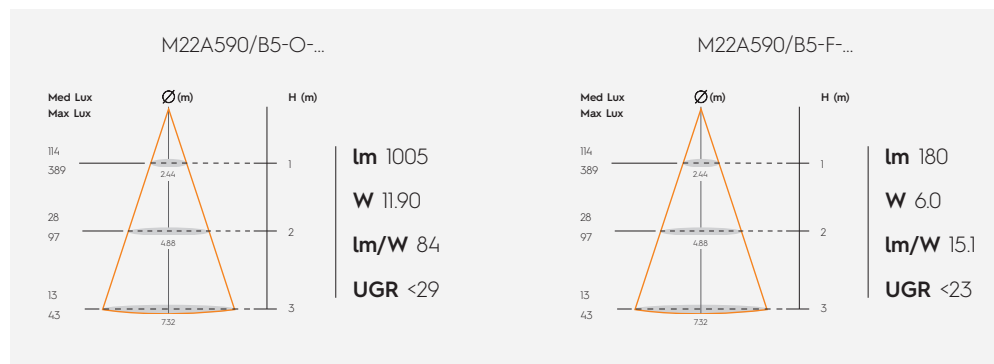
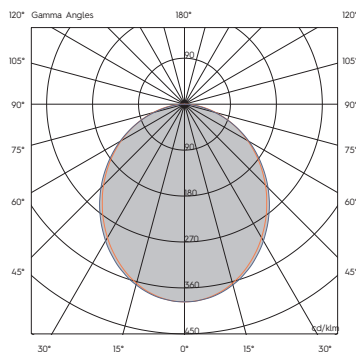

DATI TECNICI RANGE DI PRODOTTO

PRODUCT RANGE TECHNICAL DATA

MICRO

CRI \geq 90

[mm]	n°. LED Mod	[K]	I LED [mA]	FLUSSO NOMINALE [lm] NOMINAL FLUX [lm]	FLUSSO REALE [lm] REAL FLUX [lm]	POTENZA [W] POWER [W]	POTENZA LED [W] POWER LED [W]	V _F	CRI	SDCM	LIFETIME [Khr]
310	1	3000	150	710	347,1	6,1	5,3	~ 36	\geq 90	\leq 3	>50Khr L90B5
590	2	3000	300	1420	694,1	11,4	10,6	~ 36	\geq 90	\leq 3	>50Khr L90B5
870	3	3000	450	2129	1041,2	17,2	15,9	~ 36	\geq 90	\leq 3	>50Khr L90B5

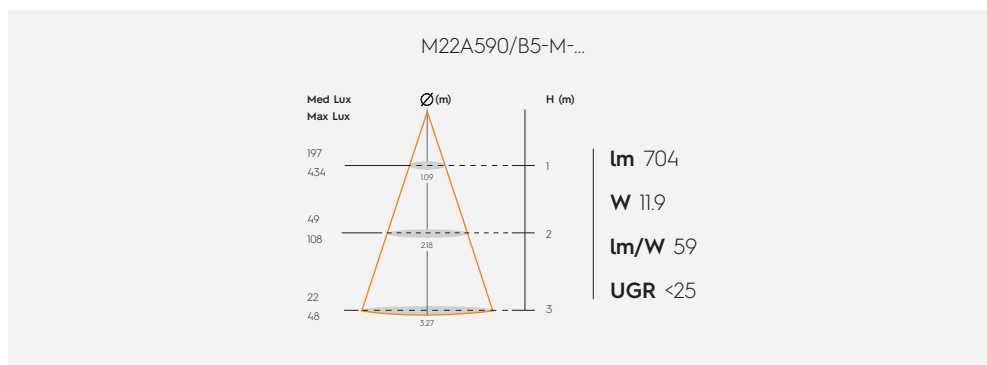
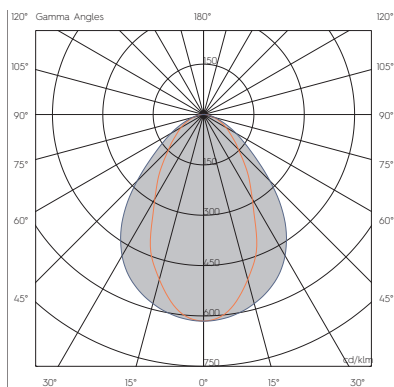

DATI TECNICI RANGE DI PRODOTTO

PRODUCT RANGE TECHNICAL DATA

LOW GLARE

CRI \geq 95

[mm]	n°. LED Mod	[K]	I LED [mA]	FLUSSO NOMINALE [lm] NOMINAL FLUX [lm]	FLUSSO REALE [lm] REAL FLUX [lm]	POTENZA [W] POWER [W]	POTENZA LED [W] POWER LED [W]	V _F	CRI	SDCM [w]	LIFETIME [Khr]
310	1	3000	250	504	412,9	5,7	4,2	~ 18	\geq 95	\leq 3	>50Khr L90B10
590	2	3000	500	1009	825,9	10,6	8,4	~ 18	\geq 95	\leq 3	>50Khr L90B10
870	3	3000	750	1513	1238,8	16,1	12,6	~ 18	\geq 95	\leq 3	>50Khr L90B10

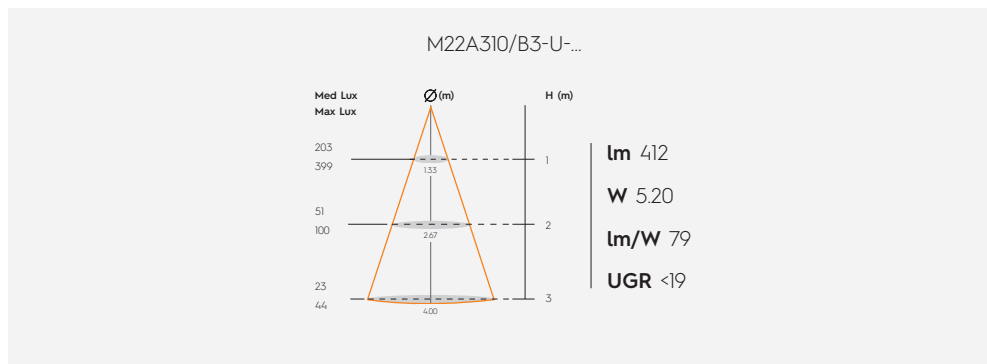
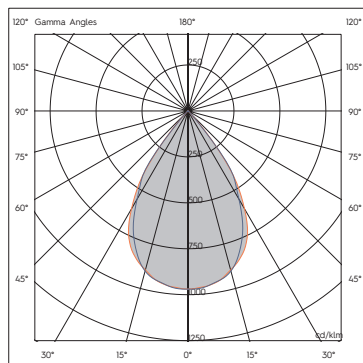

DATI TECNICI RANGE DI PRODOTTO

PRODUCT RANGE TECHNICAL DATA

LOW GLARE HIGH OUTPUT

CRI \geq 90

[mm]	n°. LED Mod	[K]	I LED [mA]	FLUSSO NOMINALE [lm] <i>NOMINAL FLUX [lm]</i>	FLUSSO REALE [lm] <i>REAL FLUX [lm]</i>	POTENZA [W] <i>POWER [W]</i>	POTENZA LED [W] <i>POWER LED [W]</i>	V _F	CRI	SDCM [W]	LIFETIME [Khr]
123	1	3000	600	709	625,2	8,3	6,9	~ 12	\geq 90	\leq 3	>60Khr L90B10
310	1	3000	300	1146	1010,7	10,3	9,9	~ 33	\geq 90	\leq 3	>60Khr L90B10

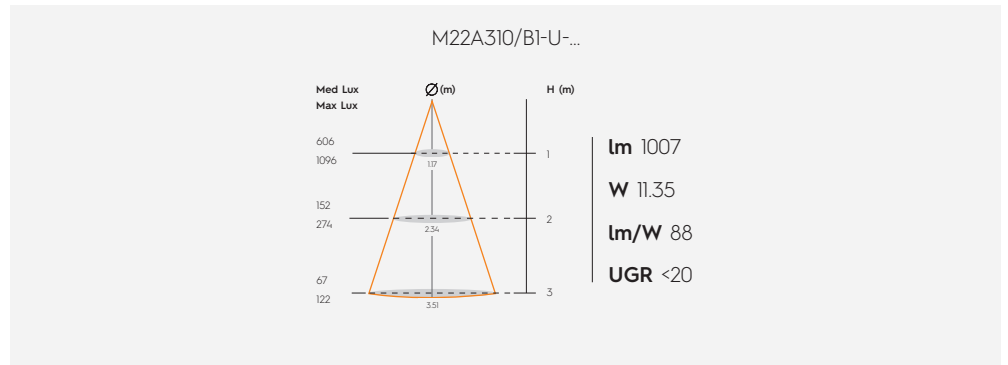
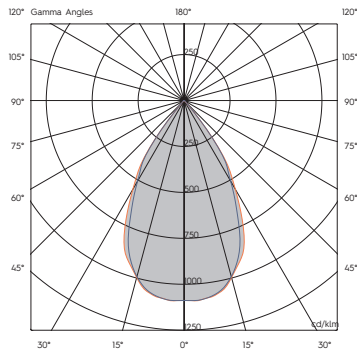

DATI TECNICI RANGE DI PRODOTTO

PRODUCT RANGE TECHNICAL DATA

LOW GLARE HIGH OUTPUT +

CRI \geq 90

[mm]	n°. LED Mod	[K]	I LED [mA]	FLUSSO NOMINALE [lm] NOMINAL FLUX [lm]	FLUSSO REALE [lm] REAL FLUX [lm]	POTENZA [W] POWER [W]	POTENZA LED [W] POWER LED [W]	V _f	CRI	SDCM [W]	LIFETIME [Khr]
310	1	3000	450	1564	1403	16,7	15	~ 33	\geq 90	\leq 3	>60Khr L90B10

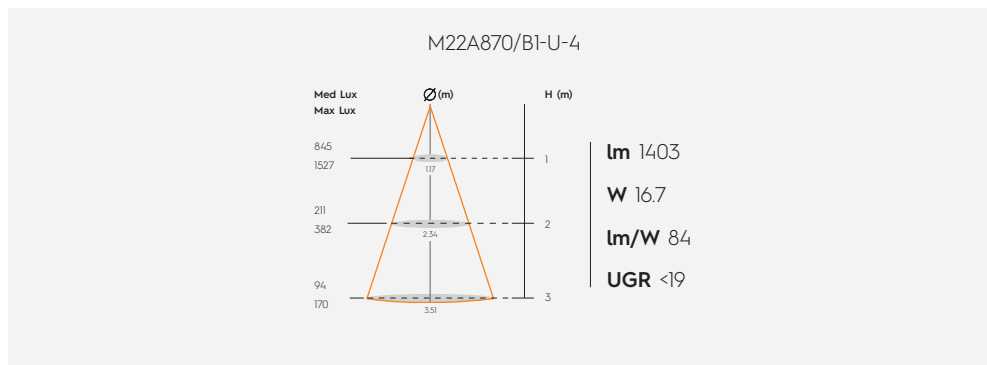
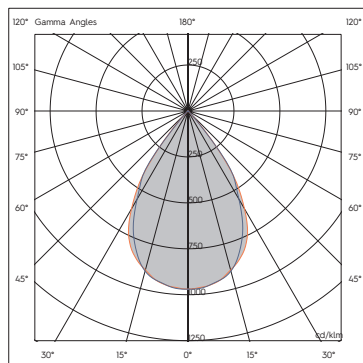

DATI TECNICI RANGE DI PRODOTTO

PRODUCT RANGE TECHNICAL DATA

LENS 20°

CRI \geq 95

[mm]	n°. LED Mod	[K]	I LED [mA]	FLUSSO NOMINALE [lm] NOMINAL FLUX [lm]	FLUSSO REALE [lm] REAL FLUX [lm]	POTENZA [W] POWER [W]	POTENZA LED [W] POWER LED [W]	V _F	CRI	SDCM	LIFETIME [Khr]
98	1	3000	600	709	549	8,3	6,9	-12	\geq 95	\leq 3	>60Khr L90B10
590	2	3000	500	1009	777,5	10,6	8,4	- 18	\geq 95	\leq 3	>50Khr L90B10
870	3	3000	750	1513	1166,3	16,1	12,6	- 18	\geq 95	\leq 3	>50Khr L90B10

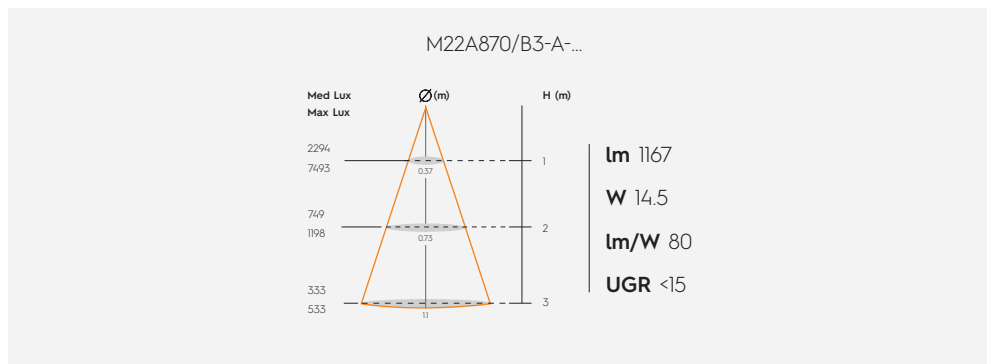
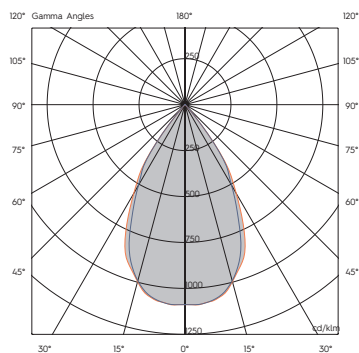

DATI TECNICI RANGE DI PRODOTTO

PRODUCT RANGE TECHNICAL DATA

LENS 30°

CRI≥95

[mm]	n°. LED Mod	[K]	I LED [mA]	FLUSSO NOMINALE [lm] NOMINAL FLUX [lm]	FLUSSO REALE [lm] REAL FLUX [lm]	POTENZA [W] POWER [W]	POTENZA LED [W] POWER LED [W]	V _f	CRI	SDCM	LIFETIME [Khr]
310	1	3000	250	504	413,8	5,7	4,2	~ 18	≥95	≤3	>50Khr L90B10
590	2	3000	500	1009	827,7	10,6	8,4	~ 18	≥95	≤3	>50Khr L90B10
870	3	3000	750	1513	1241,5	16,1	12,6	~ 18	≥95	≤3	>50Khr L90B10

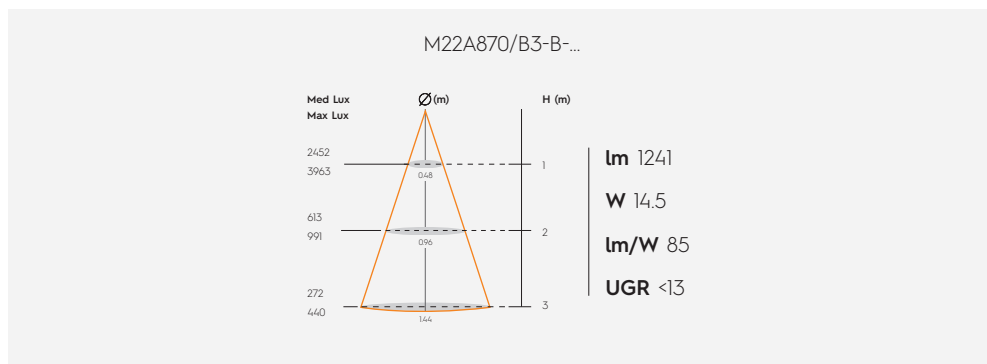
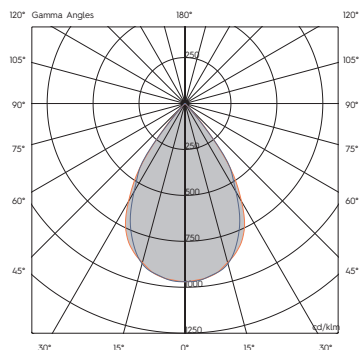

DATI TECNICI RANGE DI PRODOTTO

PRODUCT RANGE TECHNICAL DATA

LENS 26x42°

CRI≥95

[mm]	n°. LED Mod	[K]	I LED [mA]	FLUSSO NOMINALE [lm] NOMINAL FLUX [lm]	FLUSSO REALE [lm] REAL FLUX [lm]	POTENZA [W] POWER [W]	POTENZA LED [W] POWER LED [W]	V _F	CRI	SDCM	LIFETIME [Khr]
310	1	3000	250	524	372,5	5,8	4,3	~ 18	≥95	≤3	>50Khr L90B10
590	2	3000	500	1049	744,9	10,9	8,6	~ 18	≥95	≤3	>50Khr L90B10
870	3	3000	750	1573	1117,4	16,2	12,9	~ 18	≥95	≤3	>50Khr L90B10

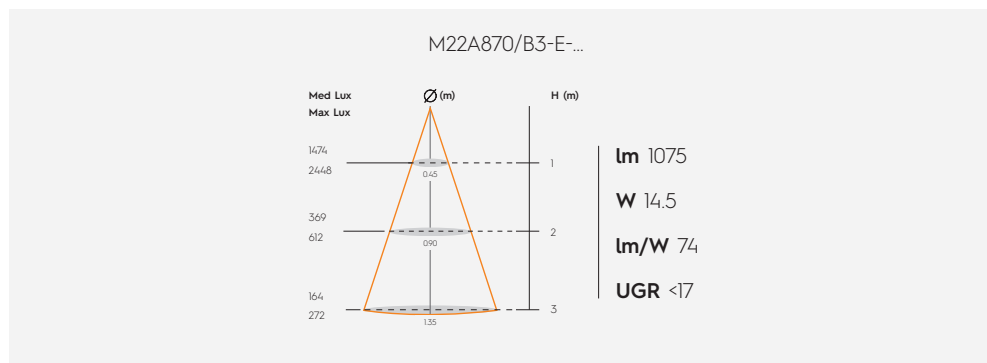
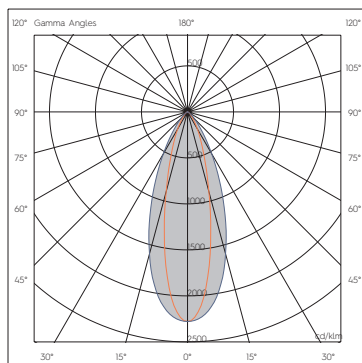

DATI TECNICI RANGE DI PRODOTTO

PRODUCT RANGE TECHNICAL DATA

LENS 20° HIGH OUTPUT

CRI \geq 90

[mm]	n°. LED Mod	[K]	I LED [mA]	FLUSSO NOMINALE [lm] NOMINAL FLUX [lm]	FLUSSO REALE [lm] REAL FLUX [lm]	POTENZA [W] POWER [W]	POTENZA LED [W] POWER LED [W]	V _f	CRI	SDCM	LIFETIME [Khr]
98	1	3000	600	709	549	8,3	6,9	-12	\geq 90	\leq 3	>60Khr L90B10

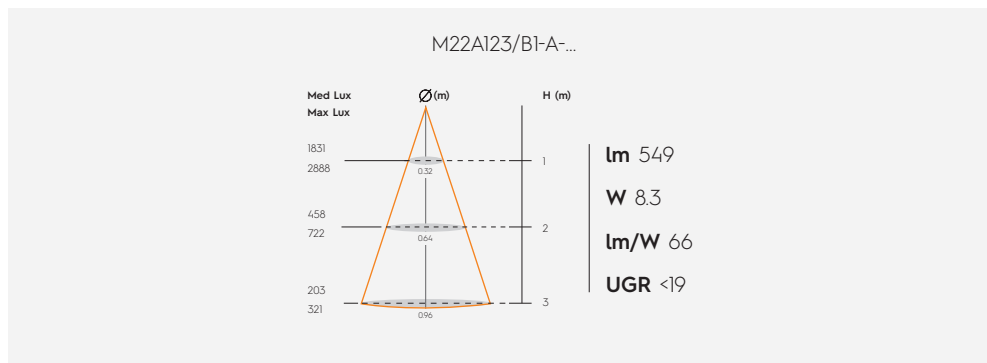
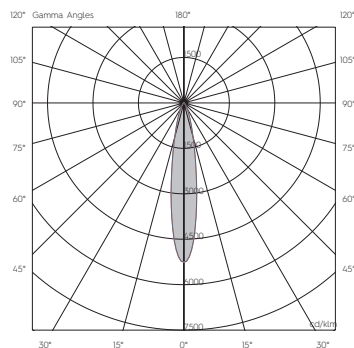

DATI TECNICI RANGE DI PRODOTTO

PRODUCT RANGE TECHNICAL DATA

LENS 30° HIGH OUTPUT

CRI \geq 90

[mm]	n°. LED Mod	[K]	I LED [mA]	FLUSSO NOMINALE [lm] NOMINAL FLUX [lm]	FLUSSO REALE [lm] REAL FLUX [lm]	POTENZA [W] POWER [W]	POTENZA LED [W] POWER LED [W]	V _f	CRI	SDCM	LIFETIME [Khr]
98	1	3000	600	709	528,4	8,3	6,9	-12	\geq 90	\leq 3	>60Khr L90B10

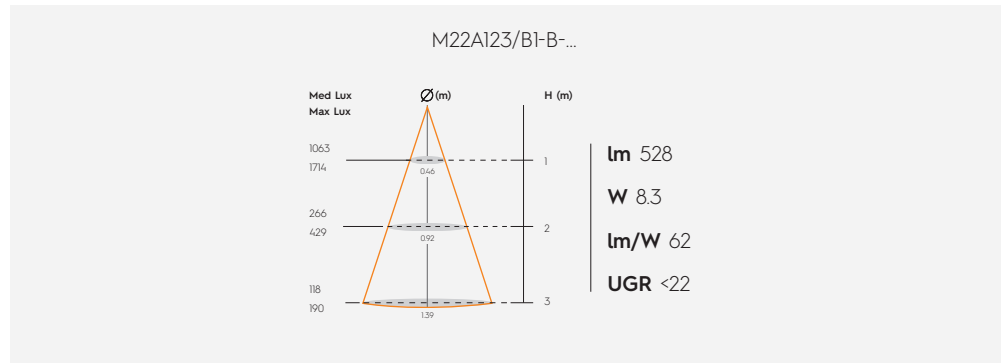
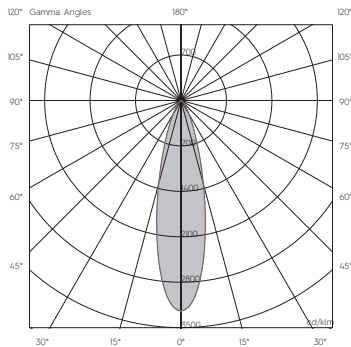

DATI TECNICI RANGE DI PRODOTTO

PRODUCT RANGE TECHNICAL DATA

LENS 26x42° HIGH OUTPUT

CRI≥90

[mm]	n°. LED Mod	[K]	I LED [mA]	FLUSSO NOMINALE [lm] NOMINAL FLUX [lm]	FLUSSO REALE [lm] REAL FLUX [lm]	POTENZA [W] POWER [W]	POTENZA LED [W] POWER LED [W]	V _f	CRI	SDCM	LIFETIME [Khr]
98	1	3000	600	709	501,1	8,3	6,9	-12	≥90	≤3	>60Khr L90B10

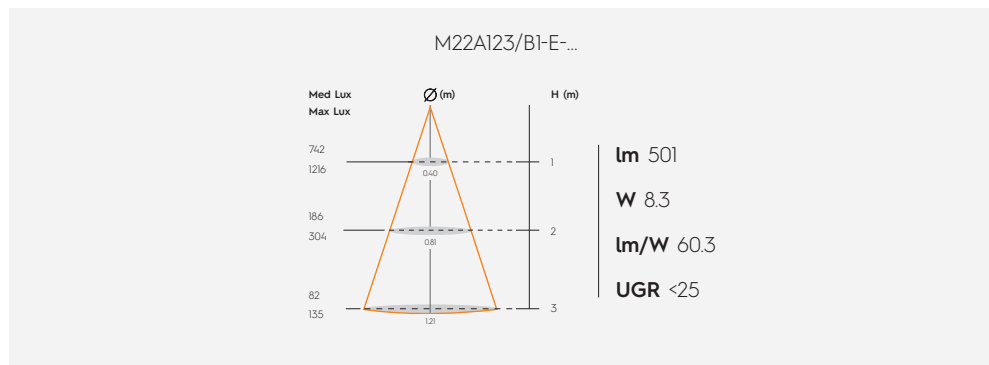
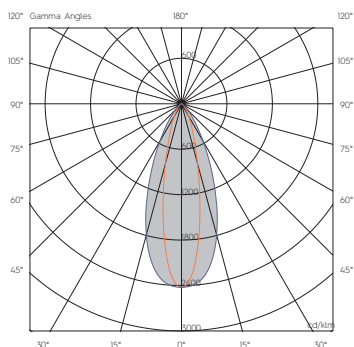

SENZAFINE TWIST

SENZAFINE TWIST è perfetto per creare luce diffusa e layout dinamici, visivamente impattanti.

SENZAFINE TWIST is the perfect product to create diffused light and dynamic high-impact layouts.

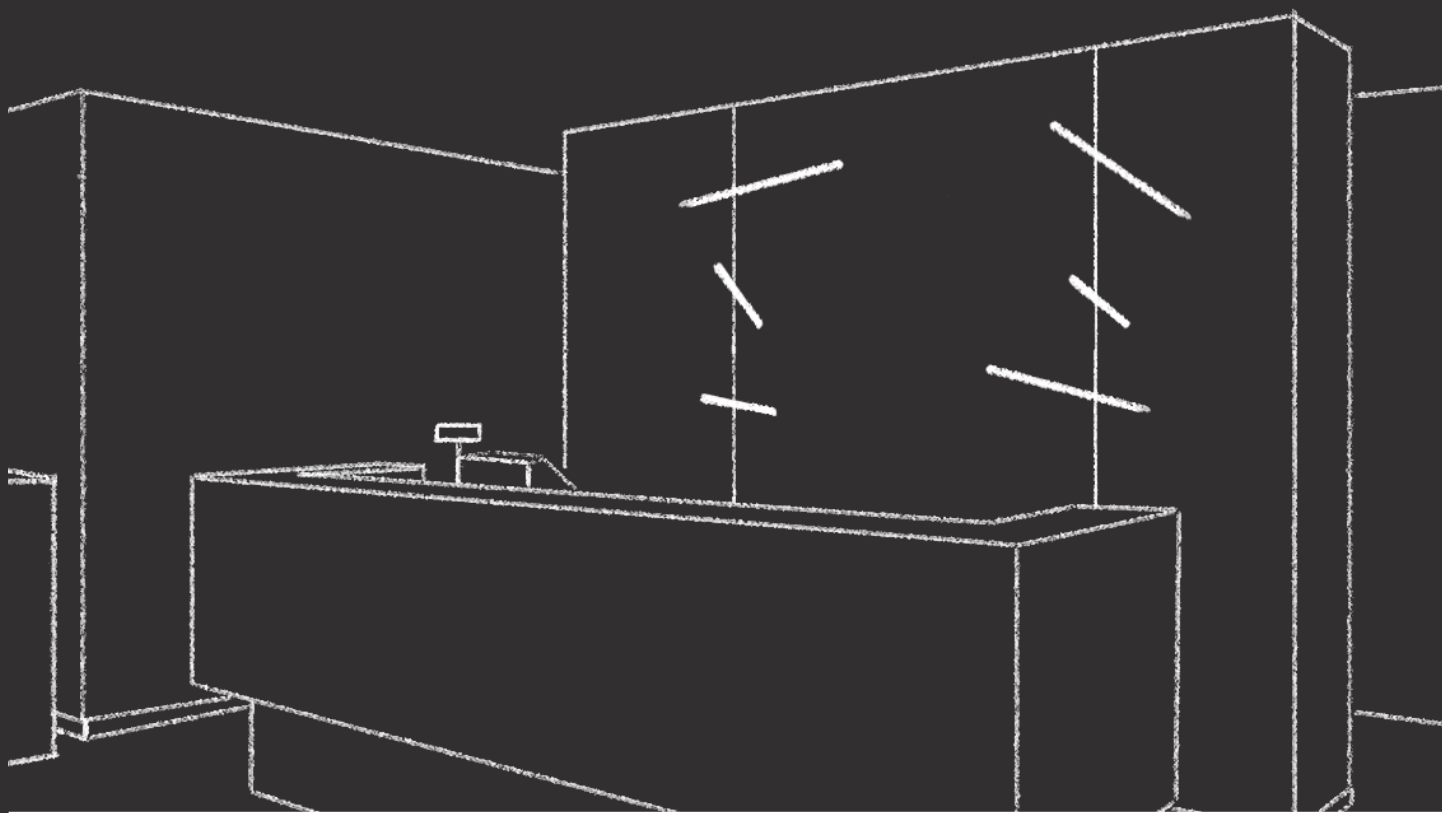

SENZAFINE TWIST

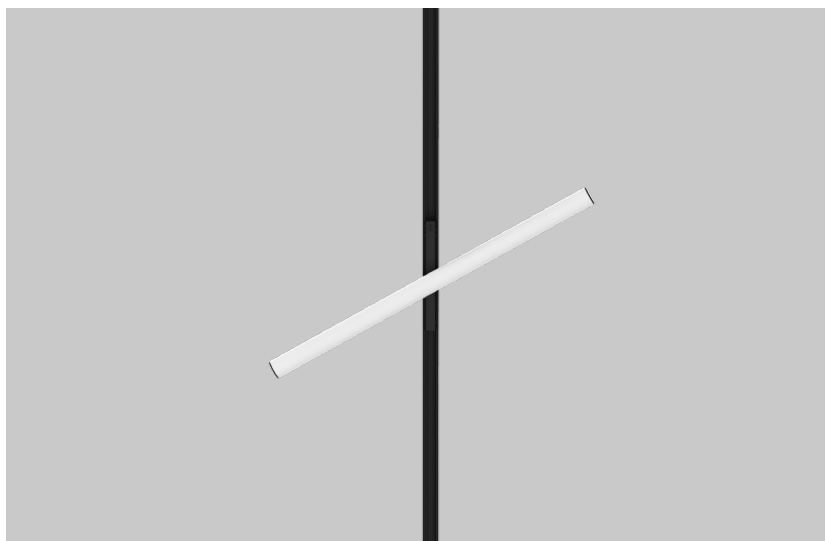
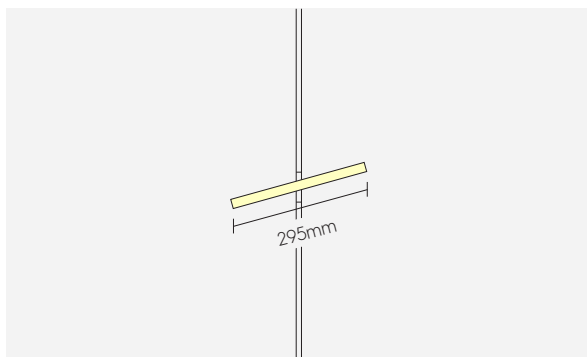

48V

IP20

RG0
at 1,2m

III
SELV

CE

Lunghezze disponibili (mm) / Available lengths (mm)

295

575

CRI

≥90

Temperatura colore (K) / Color temperature (K)

3000

Ottiche / Optics

Opalino / Opal

CONFIGURATORE CODICE

CODE CONFIGURATOR

Codice di esempio / Code example

T30S295/B5-O-2

↓ ↓ ↓ ↓ ↓ ↓ ↓
1 2 3 4 5 6 7

1 - PREFISSO / PREFIX

T30 SENZAFINE TWIST

2 - DISTANZIALE / STEM

S SHORT

H HIGH

3 - MISURA / LENGTH

————— • 295 mm ————— • 575 mm

4 - COLORE TAPPI / END CAPS COLOR

B Nero / Black

RAL 9005

5 - CARATTERISTICHE LUCE / LIGHT FEATURES

5 3000K CRI 90

6 - SCHERMI / SCREENS

0 Opalino
Opal

7 - DRIVER

2 DALI SELV

SCHEMA RIASSUNTIVO / RECAP SCHEME



ESEMPI / EXAMPLES

T30S295/B5-O-2

SENZAFINE TWIST | Distanziale short | L=295mm | Tappi neri | 3000K CRI 90 | Opalino | DALI SELV
SENZAFINE TWIST | Short stem | L=295mm | Black end caps | 3000K CRI 90 | Opal | DALI SELV

T30H575/B5-O-2

SENZAFINE TWIST | Distanziale high | L=575mm | Tappi neri | 3000K CRI 90 | Opalino | DALI SELV
SENZAFINE TWIST | High stem | L=575mm | Black end caps | 3000K CRI 90 | Opal | DALI SELV

DATI TECNICI RANGE DI PRODOTTO

PRODUCT RANGE TECHNICAL DATA

OPAL

CRI \geq 90

[mm]	n°. LED Mod	[K]	I LED [mA]	FLUSSO NOMINALE [lm] NOMINAL FLUX [lm]	FLUSSO REALE [lm] REAL FLUX [lm]	POTENZA [W] POWER [W]	POTENZA LED [W] POWER LED [W]	V _F	CRI	SDCM	LIFETIME [Khr]
295	1	3000	150	710	546	6,1	5,3	-36	\geq 90	\leq 3	>50khr L90B5
575	2	3000	300	1420	1092	11,4	10,6	-36	\geq 90	\leq 3	>50khr L90B5

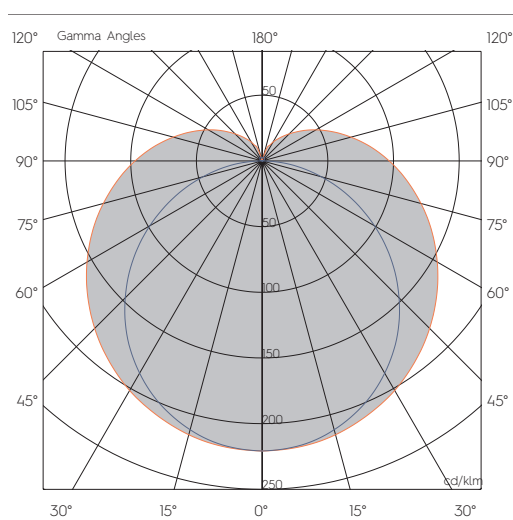

T30...295/B5-O-2

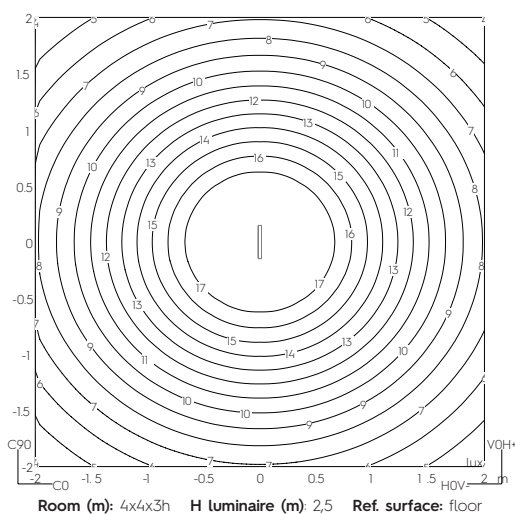

TWIST IT, SLIDE IT, MOVE IT

Pensa i tuoi progetti di illuminazione con la massima creatività e libertà di movimento.
Create your lighting projects with the maximum freedom in movement.

Scorrimento verticale
Vertical shifting

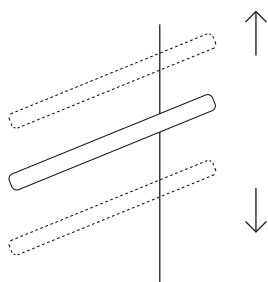

Scorrimento orizzontale
Horizontal shifting

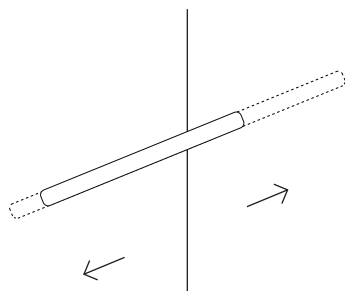

Rotazione 360°
360° rotation

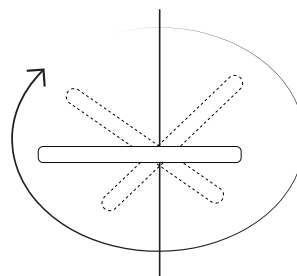

Distanziale short (S)
Short stem (S)

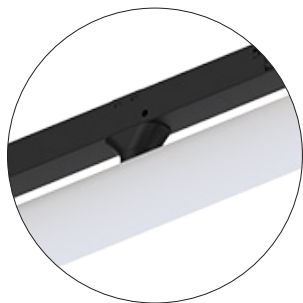

Distanziale high (H)
High stem (H)



Only for:
9500-ST1..., ST3..., ST6...,
ST8..., ST13..., ST15...

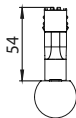

Ideal for:
9500-ST2..., ST5..., ST9...*,
ST10..., ST14 (*lower side)



SENZAFINE TWIST CROSS

SENZAFINE TWIST è perfetto per creare luce diffusa e layout dinamici, visivamente impattanti.

SENZAFINE TWIST is the perfect product to create diffused light and dynamic high-impact layouts.

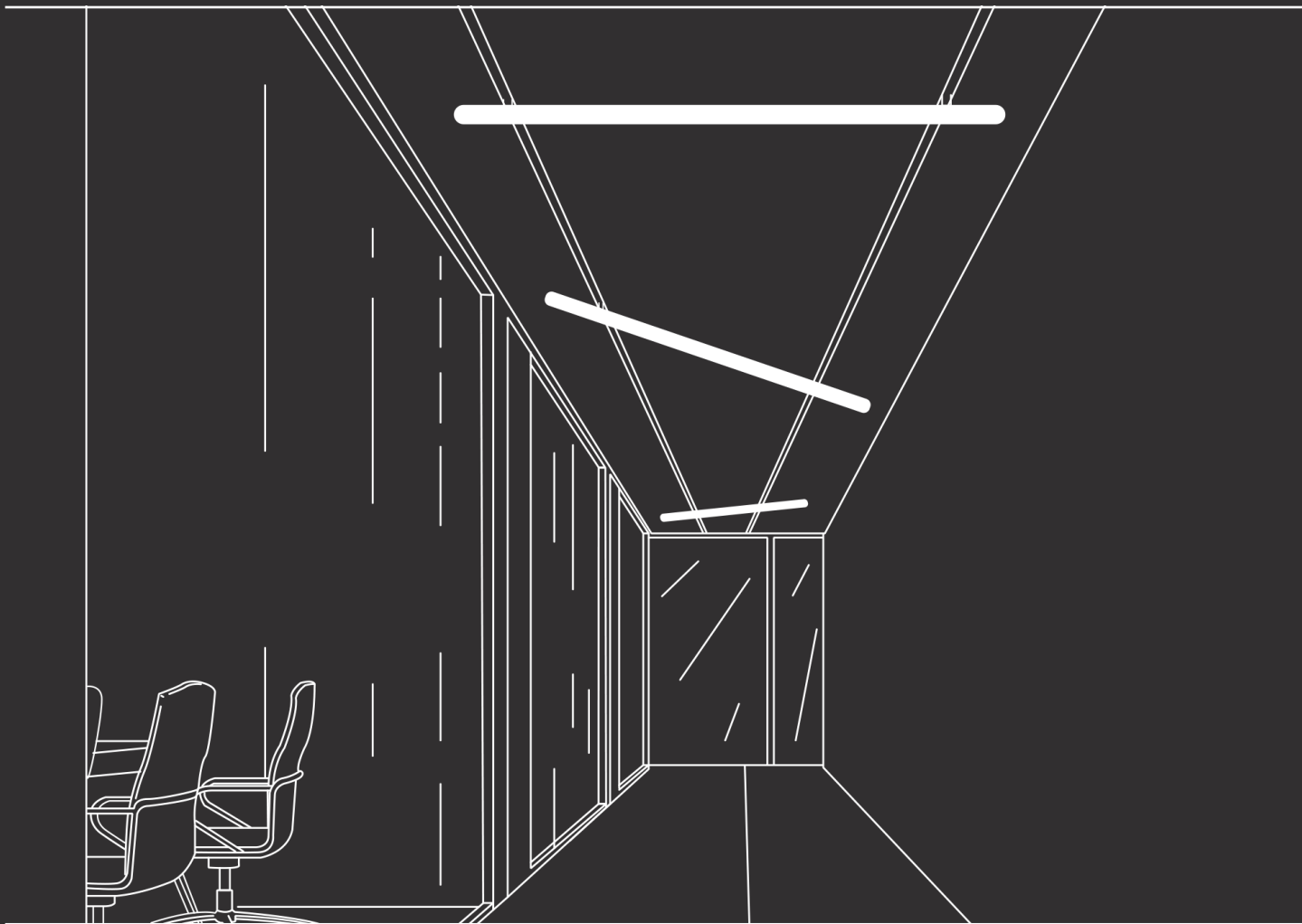

SENZAFINE TWIST CROSS

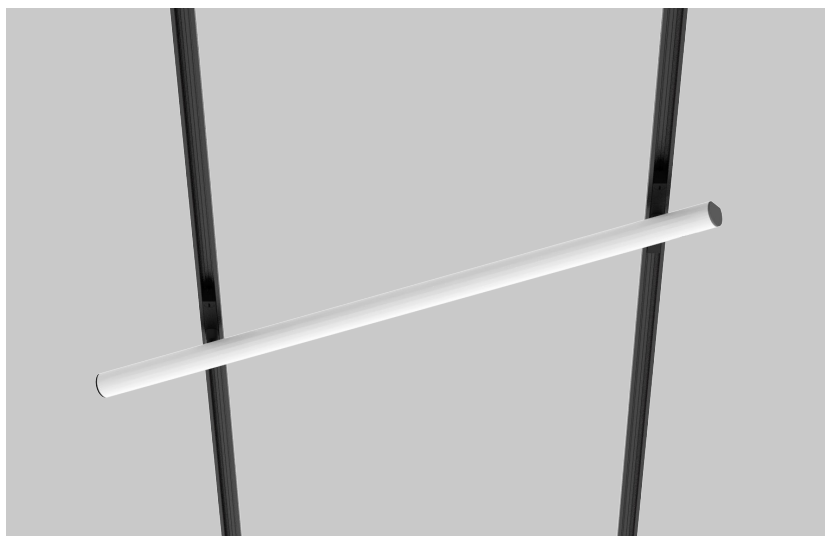
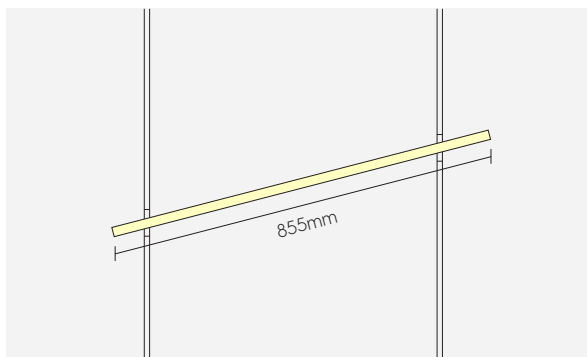

48V

IP20

RG0
at 1,2m



Lunghezze disponibili (mm) / Available lengths (mm)

855

1135

1415

CRI

≥90

Temperatura colore (K) / Colour temperature (K)

3000

Ottiche / Optics

Opalino / Opal

CONFIGURATORE CODICE

CODE CONFIGURATOR

Codice di esempio / Code example

T30CS855/B5-O-2

↓ ↓ ↓ ↓ ↓ ↓ ↓
1 2 3 4 5 6 7

1 - PREFISSO / PREFIX

T30C SENZAFINE TWIST CROSS

2 - DISTANZIALE / STEM

S SHORT

H HIGH

3 - MISURA / LENGTH

855 mm

1135 mm

1415 mm

4 - COLORE TAPPI / END CAPS COLOUR

B Nero / Black

RAL 9005

5 - CARATTERISTICHE LUCE / LIGHT FEATURES

5 3000K CRI 90

6 - SCHERMI / SCREENS

0 Opalino
Opal

7 - DRIVER

2 DALI SELV

ESEMPI / EXAMPLES

T30CS855/B5-O-2

SENZAFINE TWIST CROSS | Distanziale short | L=855mm | Tappi neri | 3000K CRI 90 | Opalino | DALI SELV
SENZAFINE TWIST CROSS | Short stem | L=855mm | Black end caps | 3000K CRI 90 | Opal | DALI SELV

T30CH1135/B5-O-2

SENZAFINE TWIST | Distanziale high | L=1135mm | Tappi neri | 3000K CRI 90 | Opalino | DALI SELV
SENZAFINE TWIST | High stem | L=1135mm | Black end caps | 3000K CRI 90 | Opal | DALI SELV

DATI TECNICI RANGE DI PRODOTTO

PRODUCT RANGE TECHNICAL DATA

OPAL

CRI \geq 90

[mm]	n°. LED Mod	[K]	I LED [mA]	FLUSSO NOMINALE [lm] NOMINAL FLUX [lm]	FLUSSO REALE [lm] REAL FLUX [lm]	POTENZA [W] POWER [W]	POTENZA LED [W] POWER LED [W]	V _F	CRI	SDCM	LIFETIME [Khr]
855	3	3000	450	2129	1638	17,2	15,9	-36	\geq 90	\leq 3	>50Khr L90B5
1135	4	3000	600	2839	2184	22,9	21,2	-36	\geq 90	\leq 3	>50Khr L90B5
1415	5	3000	750	3549	2730	28,8	26,5	-36	\geq 90	\leq 3	>50Khr L90B5

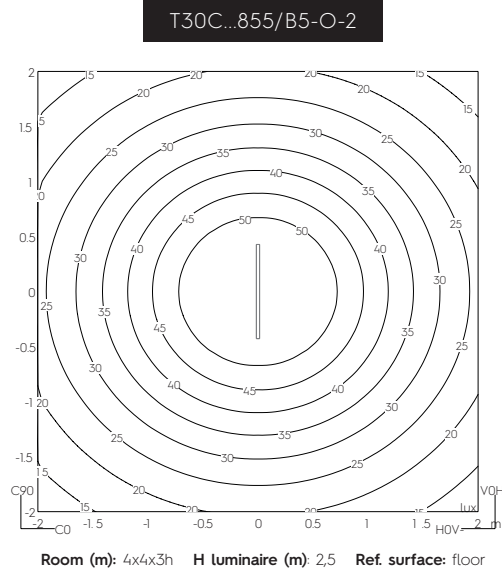
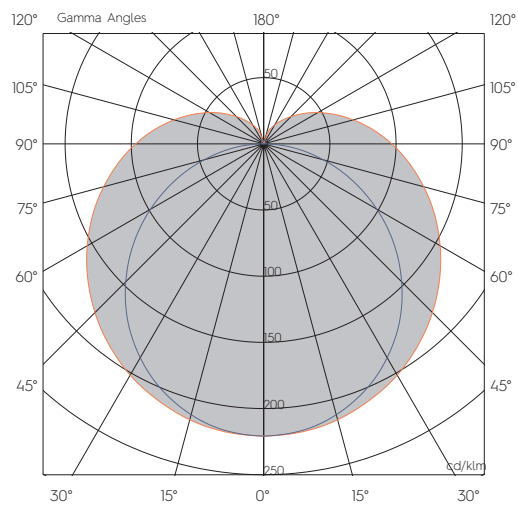

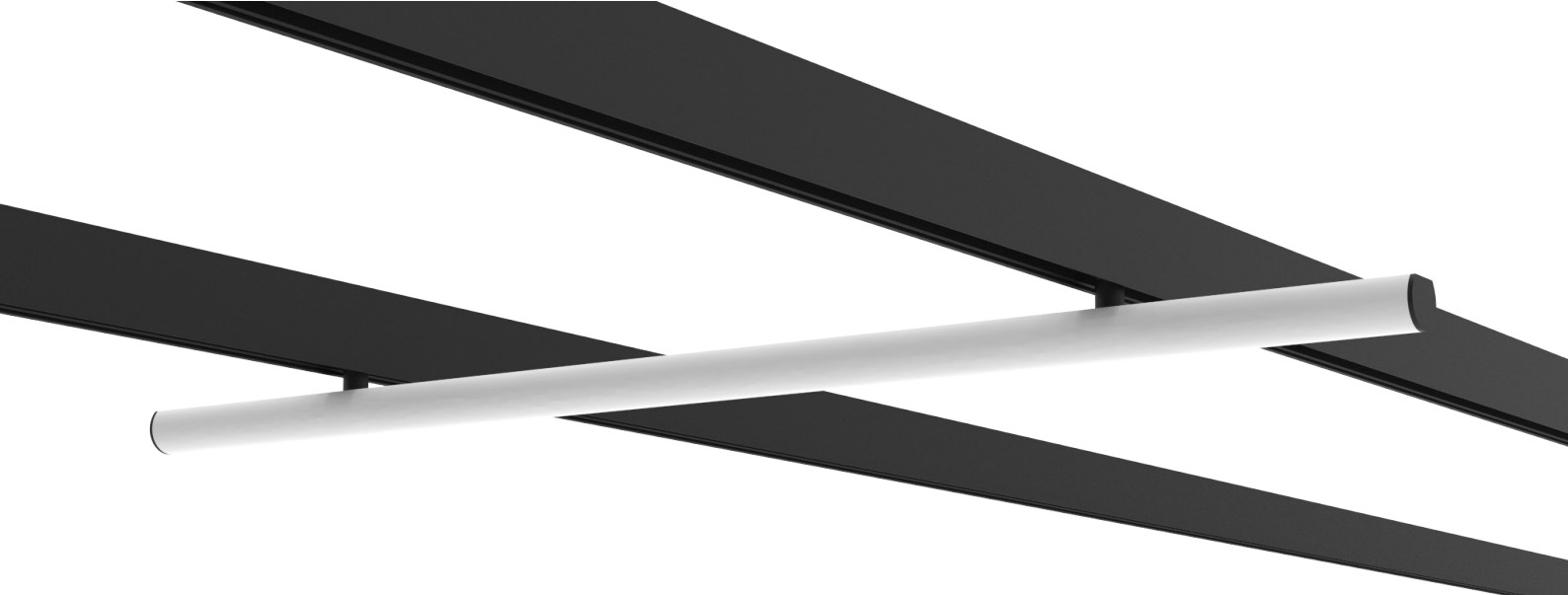

Scorrimento verticale
Vertical shifting

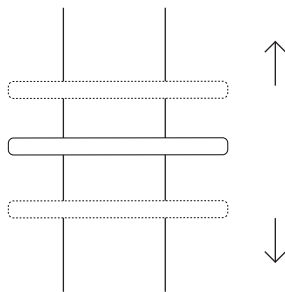

Scorrimento orizzontale
Horizontal shifting

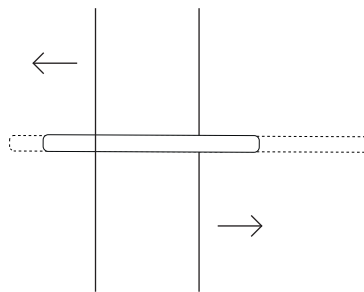

Rotazione
Rotation

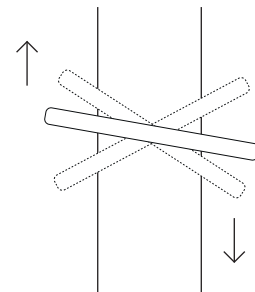

Distanziale short (S)
Short stem (S)

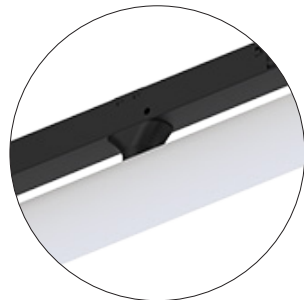

Only for:
9500-ST1..., ST3..., ST6...,
ST8..., ST13..., ST15...

Distanziale high (H)
High stem (H)

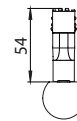

Ideal for:
9500-ST2..., ST5..., ST9...*,
ST10..., ST14 (*lower side)

MULTISYSTEM READY L26R

L26R con ottica UGR<19, grazie al comfort visivo elevato è adatto ad essere utilizzato in ambienti di lavoro con video terminale.

L26R with UGR<19 optic thanks to its high visual comfort is suitable for use in working places with display screens.



L26R - Binario a sospensione con luce biemissione

L26R - Suspended track with double emission light

L26R combina la flessibilità di un binario con le performance tecniche di SENZAFINE per fornire un apparecchio di illuminazione pronto all'uso, comprensivo di luce indiretta, accessori di fissaggio ed elettronica.

L26R combines the flexibility of a track with the technical performance of SENZAFINE, to provide a "ready to use" lighting fixture including indirect light, fixing accessories and electronics.



CONFIGURATORE CODICE

CODE CONFIGURATOR

Codice di esempio / Code example

L26RSB/B1-U-3

↓ ↓ ↓ ↓ ↓ ↓
1 2 34 5 6

1 - PREFISSO / PREFIX

L26R MULTISYSTEM READY L26R (L=1408mm)

2 - TIPO DI APPARECCHIO / APPLICATION TYPE

SB Sospensione Biemissione / *Biemission Suspended*



3 - COLORE E FINITURA / COLOUR AND FINISHING

B Nero gofrato / *Black embossed*
RAL 9005

W2 Bianco gofrato / *White embossed*
RAL 9016

BR Marrone gofrato / *Brown embossed*

4 - CARATTERISTICHE LUCE / LIGHT FEATURES

1 3000K CRI 90

5 - SCHERMI - LUCE DIRETTA / SCREENS - DIRECT LIGHT

U UGR

6 - DRIVER

0 ON - OFF

3 BLE CONTROL

DATI TECNICI

TECHNICAL DATA

LUCE DIRETTA+INDIRETTA / DIRECT+INDIRECT LIGHT

[K]	n°. LED Mod	I LED [mA]	FLUSSO NOMINALE [lm] NOMINAL FLUX [lm]	FLUSSO REALE [lm] REAL FLUX [lm]	POTENZA [W] POWER [W]	POTENZA LED [W] POWER LED [W]	V _f	CRI	SDCM	LIFETIME [Khr]
3000	4+2	-	5976	4436	55,0	46,8	-	≥90	≤3	>50Khr L90B5

LUCE DIRETTA / DIRECT LIGHT

3000	4	750	3732	2422	32,2	27,0	36	≥90	≤3	>50Khr L90B5
------	---	-----	------	------	------	------	----	-----	----	--------------

LUCE INDIRETTA / INDIRECT LIGHT

3000	2	300	2244	2014	2x11,4	2x9,9	39	≥90	≤3	>50Khr L90B5
------	---	-----	------	------	--------	-------	----	-----	----	--------------

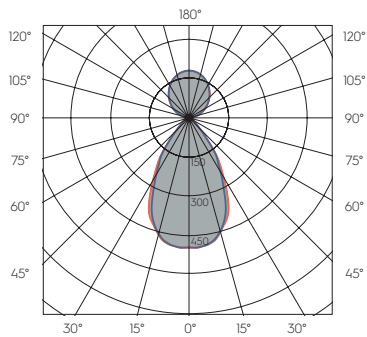

L26RSB/B1-U-...

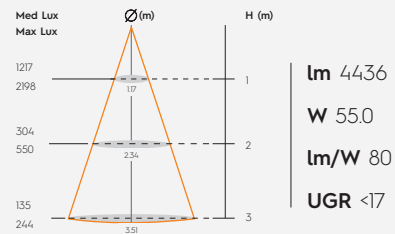

COMPOSIZIONE MECCANICA

MECHANICAL COMPOSITION

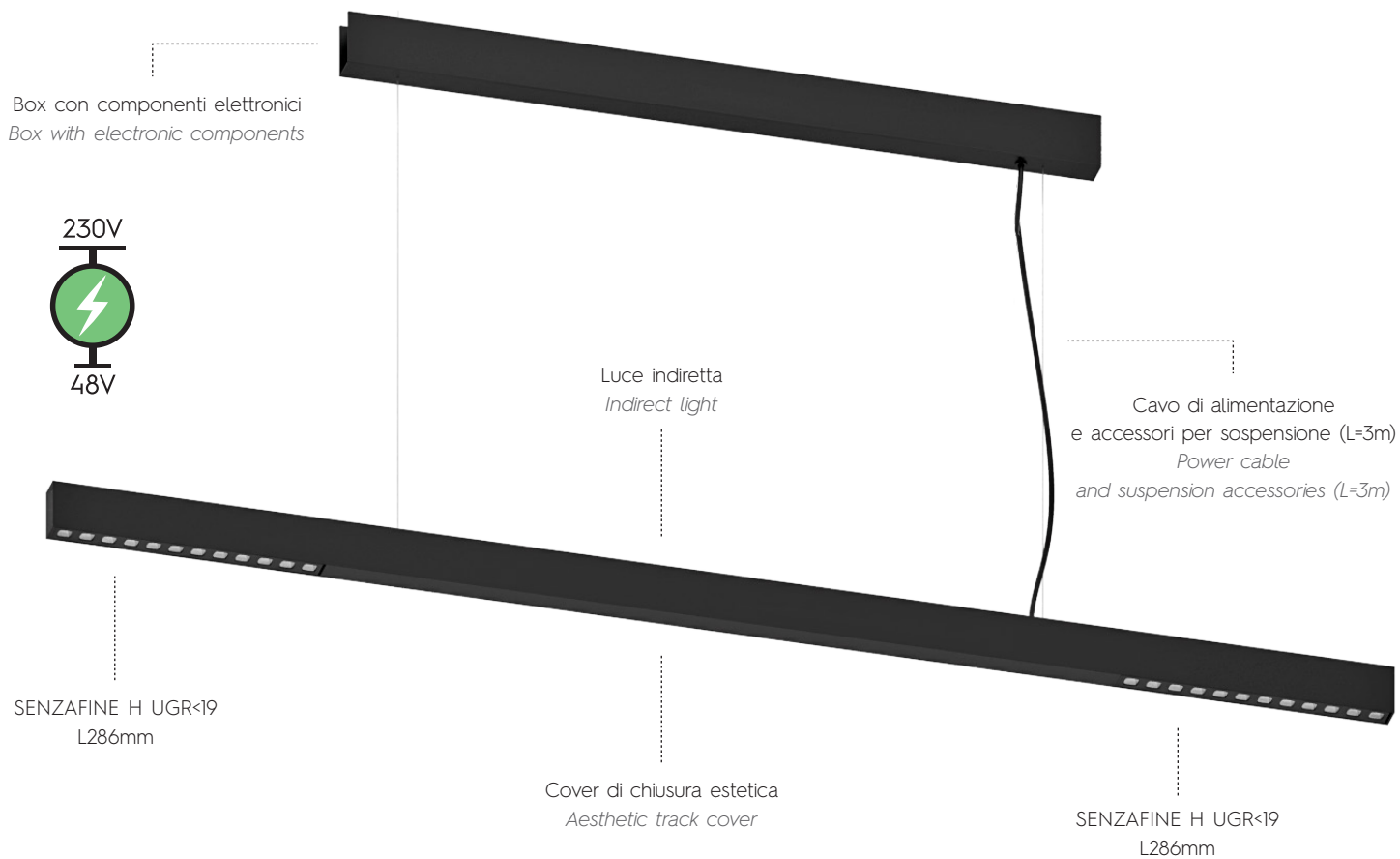

ALTRE IDEE DI COMPOSIZIONE PRODOTTO

OTHER PRODUCT COMPOSITION IDEAS

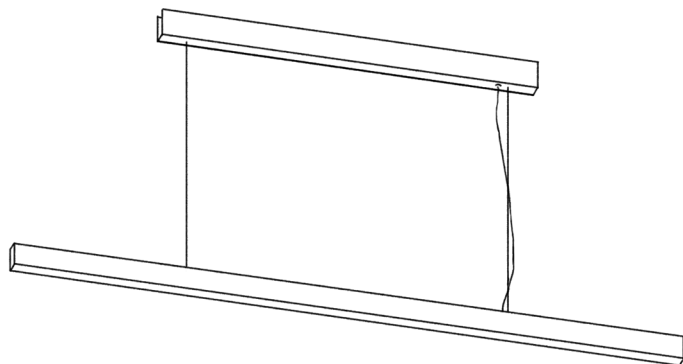

SENZAFINE OPAL L=1408mm

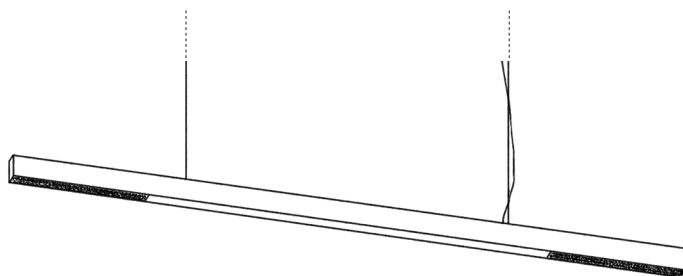

SENZAFINE OPAL L=847mm
+ Cover di chiusura estetica
+ *Aesthetic track cover*

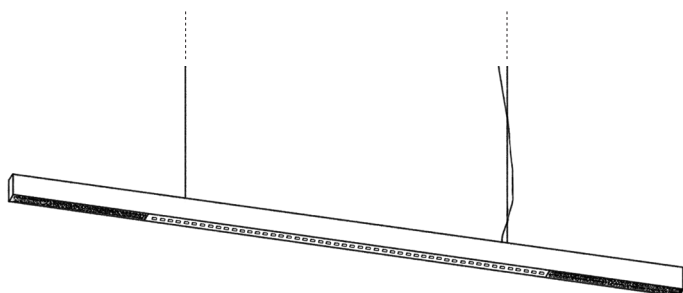

SENZAFINE UGR<19 L=847mm
+ Cover di chiusura estetica
+ *Aesthetic track cover*

MULTISYSTEM READY H26

H26, con la sua luce indiretta diffusa è ideale per rendere piacevoli e confortevoli gli ambienti di accoglienza.

H26 with its diffused indirect light is perfect to make waiting rooms or receptions comfortable and cozy.

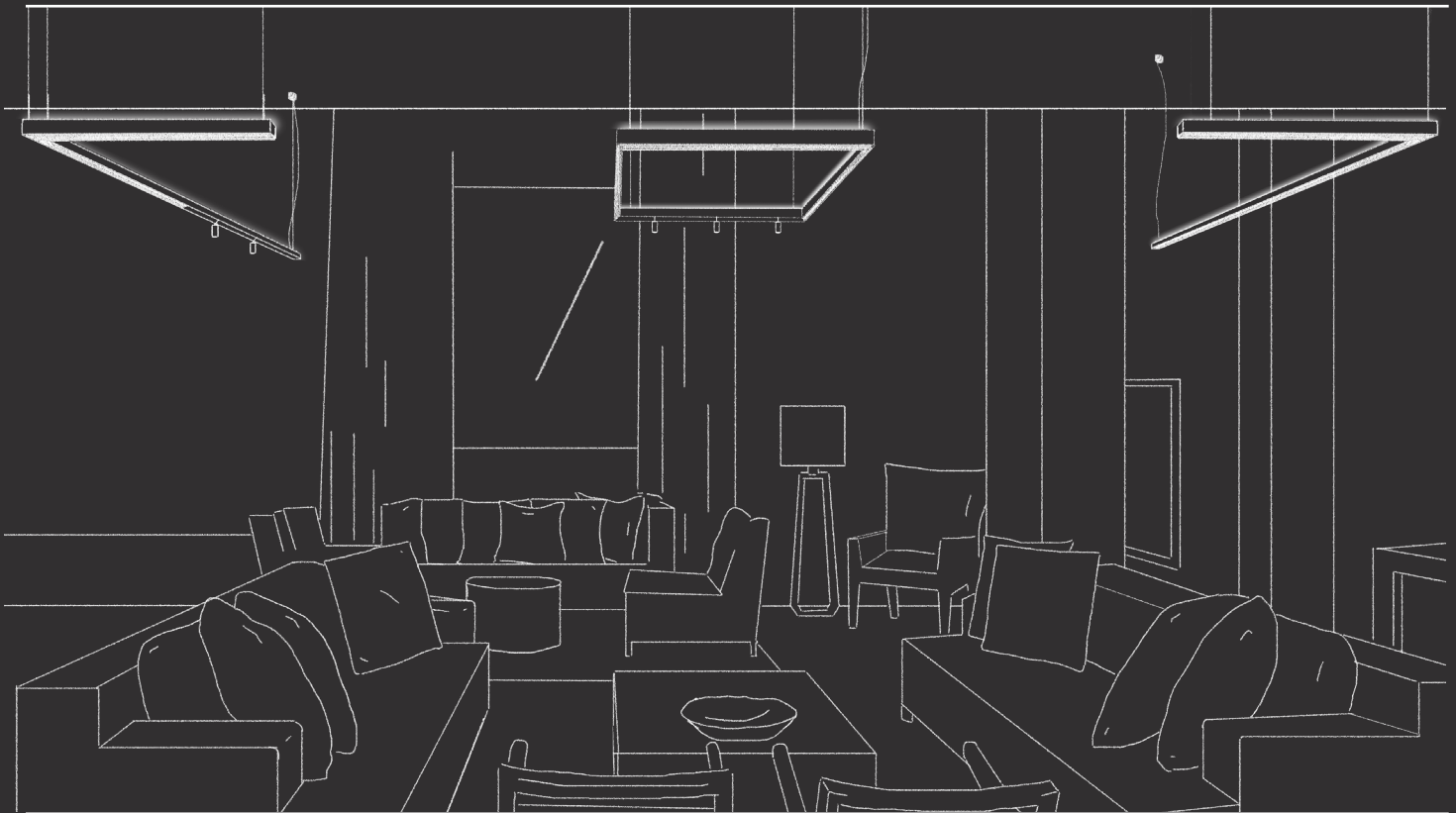

H26 - Binario a sospensione per fila continua con luce indiretta

H26 - Suspended in row track with indirect light

Il binario **MULTISYSTEM ST2**, fornito in versione "READY" con luce indiretta incorporata è disponibile in due diverse lunghezze che possono essere unite in fila continua e in composizioni rettangolari. H26 è ideale per creare sistemi di luce che si adattano alle varie esigenze di progetto.

*H26 is **MULTISYSTEM ST2** track, supplied in "ready to use" mode with indirect light included is available in two lengths that can be used in row and rectangular compositions. H26 is ideal to create lighting systems in accordance to the projec's need.*



GIUNZIONE IN FILA CONTINUA
IN ROW JUNCTION

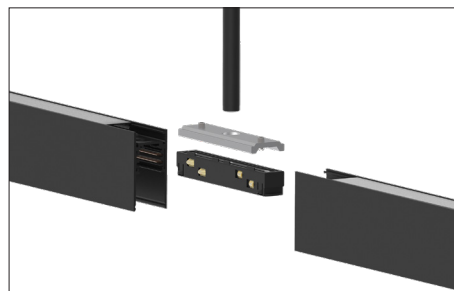

CONFIGURATORE CODICE

CODE CONFIGURATOR

Codice di esempio / Code example

H261402/B5-O-2

↓ ↓ ↓ ↓ ↓ ↓
1 2 3 4 5 6

1 - PREFISSO / PREFIX

H26

2 - MISURA / LENGTH

1402 mm 2802 mm

3 - COLORE E FINITURA / COLOUR AND FINISHING

B Nero gofrato / Black embossed RAL 9005
W2 Bianco gofrato / White embossed RAL 9016

4 - CARATTERISTICHE LUCE / LIGHT FEATURES

5 3000K CRI 90*

5 - SCHERMI / SCREENS

O Opalino $T_L = 56\%$
Opal $T_L = 56\%$

6 - DRIVER

1 I-10 2 DALI SELV

*Altre temperature colore e CRI disponibili su richiesta
*Other colour temperatures and CRI available upon request

PERFORMANCE DI PRODOTTO E DATI TECNICI

PRODUCT PERFORMANCES AND TECHNICAL DATA

CRI \geq 90

[mm]	[K]	FLUSSO NOMINALE [lm] NOMINAL FLUX [lm]	FLUSSO REALE [lm] REAL FLUX [lm]	POTENZA [W] POWER [W]	POTENZA LED [W] POWER LED [W]	V _F	CRI	SDCM	LIFETIME [Khr]
1402	3000	2600	1900	20,9	19,2	48	\geq 90	\leq 3	>50Khr L90B5
2802	3000	5850	4275	45,0	43,2	48	\geq 90	\leq 3	>50Khr L90B5

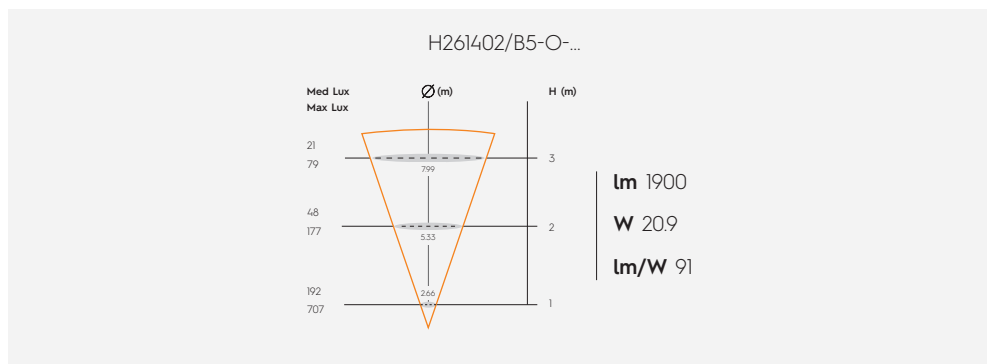
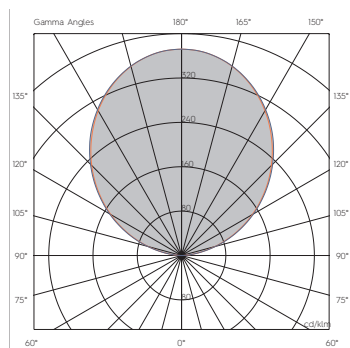

ACCESSORI

ACCESSORIES

W - W2 = Bianco / White
 B = Nero / Black
 C1 = A plafone / Ceiling tracks
 SP = A sospensione / Suspended tracks

9504/ST2-B / 9504/ST2-W2
 9504/ST2-B-F / 9504/ST2-W2-F



Tappe di chiusura in lamiera (...F= con foro per cavo)
Metal sheet end cap (...F= with hole for cable)

9504/ST2-P-B / 9504/ST2-P-W2
 9504/ST2-P-B-F / 9504/ST2-P-W2-F

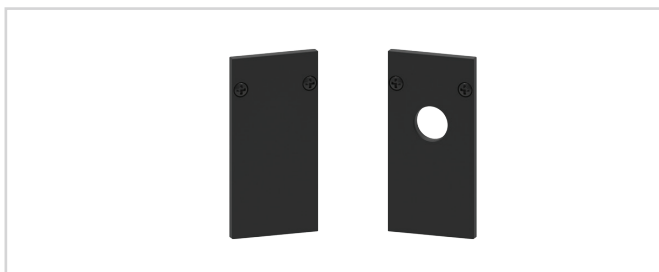

Tappe di chiusura in plastica (...F= con foro per cavo)
Plastic end cap (...F= with hole for cable)

9501-KL/B / 9501-KL/W



Testata sinistra
End feed - left

9501-S-KL/B-E / 9501-S-KL/W-E



Testata sinistra ridotta
Short End feed - left

9503-S-K/B-E / 9503-S-K/W-E

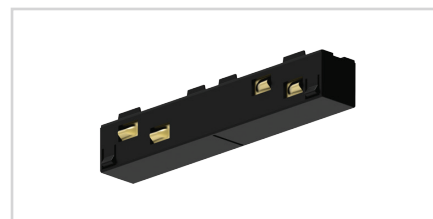

Giunto passante ridotto
Short jointing connector

9500/P-100E-..-SP-N



Box di alimentazione per binari a sospensione
Power supply for suspended tracks

9511-KE/B-E / 9511-KE/W-E



Giunto a L polarizzato esterno
External polarized L feed

9511-KI/B-E / 9511-KI/W-E



Giunto a L polarizzato interno
Internal polarized L feed

ACCESSORI

ACCESSORIES

9513-K/B-E / 9513-K/W-E



Giunto a T polarizzato binario ST2
Polarized T joint for ST2 track

9514-K/B-E / 9514-K/W-E



Giunto a T polarizzato binario ST2
Polarized T joint for ST2 track

9515-K/B-E / 9515-K/W-E



Giunto a T polarizzato binario ST2
Polarized T joint for ST2 track

9516-K/B-E / 9516-K/W-E



Giunto a T polarizzato binario ST2
Polarized T joint for ST2 track

9517-K/B-E / 9517-K/W-E



Giunto a X polarizzato binario ST2
Polarized X joint for ST2 track

9513/B-E / 9513/W-E



Giunto a T binario ST2
T joint for ST2 track

9517/B-E / 9517/W-E



Giunto a X binario ST2
X joint for ST2 track

S-9511/B-ST2 / S-9511/W2-ST2



Cover per giunto a L binario ST2
Cover for L joint for ST2 track

S-9511/B-P-ST2 / S-9511/W2-P-ST2



Giunto meccanico a L binario ST2
Mechanical L joint for ST2 track

ACCESSORI

ACCESSORIES

S-9513/B-P-ST2 / S-9513/W2-P-ST2



Giunto meccanico a T binario ST2
Mechanical T joint for ST2 track

S-9517/B-P-ST2 / S-9517/W2-P-ST2



Giunto meccanico a X binario ST2
Mechanical X joint for ST2 track

S-RP-24-48V



Ripetitore per optoisolare il Bus Data in ingresso
Repeater to opto-insulate the Bus Data input signal

9500-KIT1-1,5
 9500-KIT1-3
 9500-KIT1-5

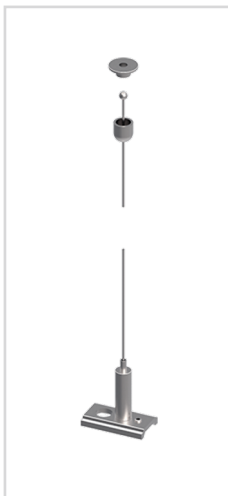

Composto da:

- rosone metalico sferico con foro
- filo in acciaio \varnothing 1,5mm
(L=1500/3000/5000mm)
con estremità sferica
- staffa con tenditore automatico

Includes:

- round head ceiling attachment
- steel cable \varnothing 1,5mm
(L=1500/3000/5000mm)
with spherical end
- bracket with automatic gripper

9500-KIT2-1,5
 9500-KIT2-3
 9500-KIT2-5

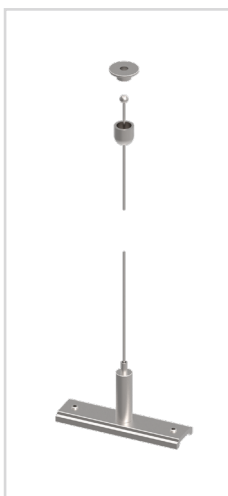

Composto da:

- rosone metalico sferico con foro
- filo in acciaio \varnothing 1,5mm
(L=1500/3000/5000mm)
con estremità sferica
- staffa con tenditore automatico

Includes:

- round head ceiling attachment
- steel cable \varnothing 1,5mm
(L=1500/3000/5000mm)
with spherical end
- bracket with automatic gripper

MULTISYSTEM READY P26

P26 insieme ad un modulo di luce lineare SENZAFINE OPAL L1125mm è l'ideale per creare luce d'ambiente in contesti home living.

P26 together with SENZAFINE OPAL L1125mm light module is ideal to create ambient light for home living applications.

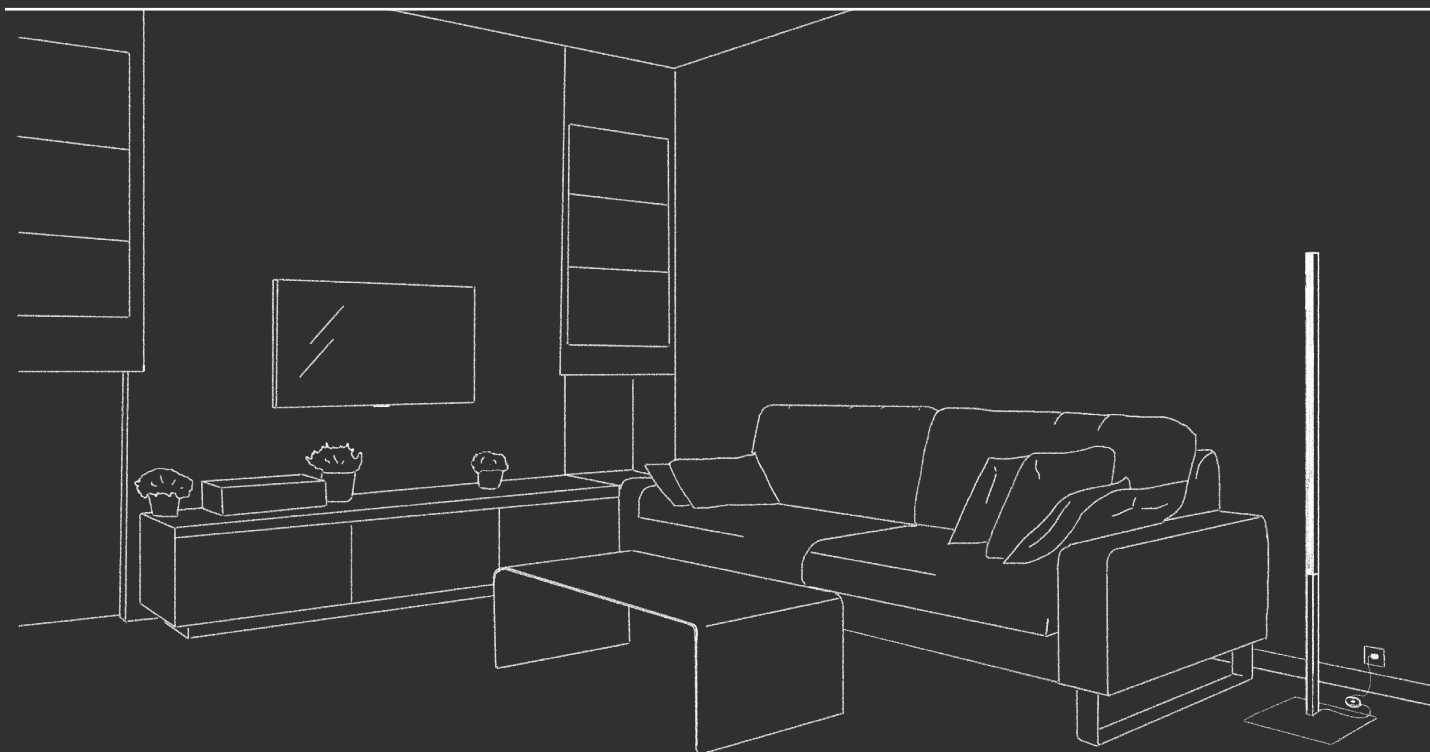

P26 - Binario da terra standalone

P26 - Floor standing track

P26 è una piantana, ovvero una struttura standalone verticale costituita da un binario ST2 su una base quadrata. P26 porta tutta la flessibilità della luce a binario in un prodotto mobile adatto ai più svariati utilizzi. Il prodotto è dotato di alimentazione plug&play a 230V, mentre i corpi illuminanti da utilizzare al suo interno (NON INCLUSI) sono a bassa tensione.

P26 is a floor standing standalone structure composed by vertical ST2 track with squared base. P26 brings all the flexibility of track lighting in a movable product suitable for several applications. The product provides plug&play power supply 230V while the luminaires to be used with it are Low voltage luminaires (NOT INCLUDED).



CONFIGURATORE CODICE

CODE CONFIGURATOR

Codice di esempio / Code example

P261870/B

1 2 3

1 - PREFISSO / PREFIX

P26

2 - ALTEZZA / HEIGHT



3 - COLORE E FINITURA / COLOUR AND FINISHING

B

Nero gofrato / *Black embossed*

RAL 9005

W2

Bianco gofrato / *White embossed*

RAL 9016

COMPOSIZIONE MECCANICA

MECHANICAL COMPOSITION

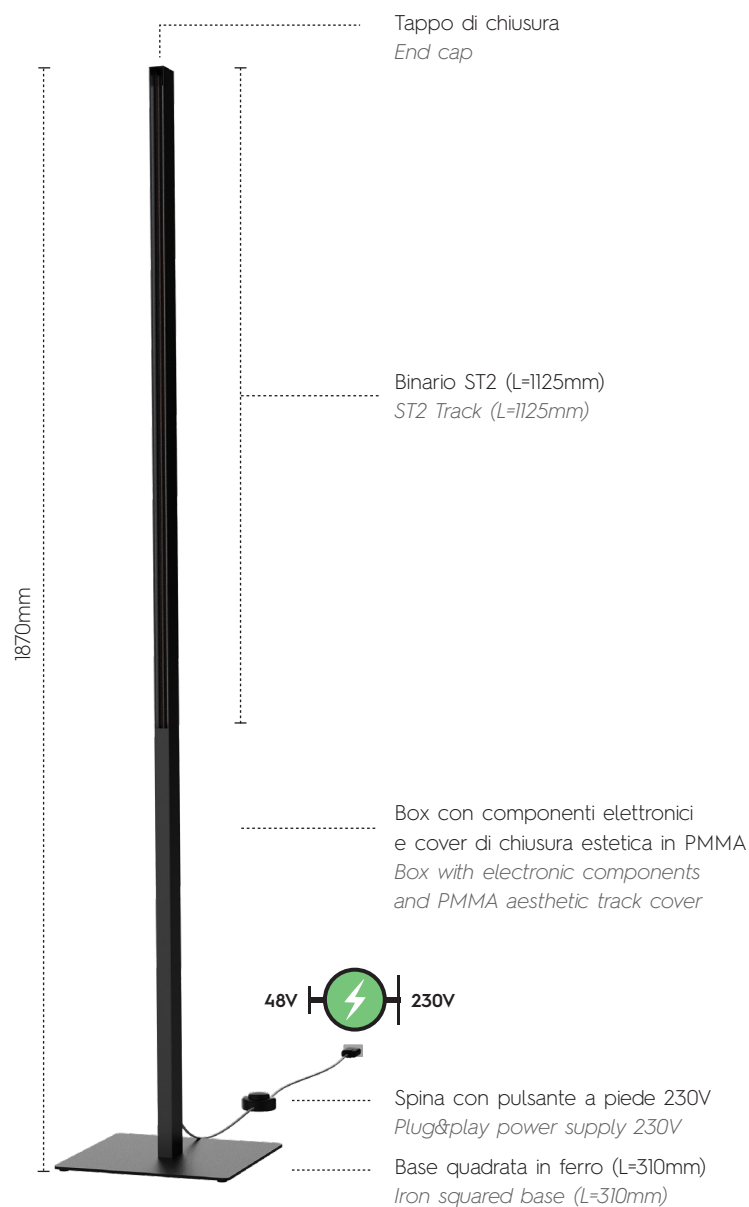

LEGENDA SIMBOLI / SYMBOLS LEGEND



Rischio fotobiologico e distanza di soglia
Photobiological risk and treshold distance



Rischio fotobiologico basso / *Photobiological low risk*



Classe energetica riferita a tutti i prodotti forniti con moduli led integrati e non sostituibili.
Energy Efficiency class referred to all products supplied with integrated LED module, not replaceable.

Secondo il regolamento N847/2012. / *In compliance with Directive N847/2012*



Apparecchio per collegamento ad impianti a basso voltaggio. / *Anti-shock protection depends on safety low-power voltage.*



Il prodotto risponde ai requisiti essenziali di sicurezza dell'Unione Europea. / *Product complies with essential safety requirement of European Union market.*

L'azienda declina ogni responsabilità per eventuali errori di stampa. I dati tecnici relativi ai prodotti possono essere aggiornati in qualsiasi momento.
The company declines any misprinting responsibility. Technical data can be updated at any time.

A.A.G. STUCCHI s.r.l. u.s.
Via IV Novembre 30/32, 23854
Olginate (LC) - ITALY
Ph. +39-0341-653111
Fax +39-0341-653250
info@aagstucchi.it

A.A.G. STUCCHI NORTH AMERICA, INC.
5080 North Royal Atlanta Drive
Tucker, GA 30084 - USA
Ph. +1-404-806-5399
northamerica@aagstucchi.com

A.A.G. STUCCHI ASIA PACIFIC LTD.
Regional office
Room 01, 11/fl., New Treasure Centre
N° 10 Ng Fong Street, Kowloon - HONG KONG
Ph. +852-2578-8988
Fax +852-2571-5039
hongkong@aagstucchi.hk

A.A.G. STUCCHI SHANGHAI LTD.
Rm 3007, N°738, Chang Yang Rd
YangPu area, 200082 - SHANGHAI
Ph. +86-21-51816507
Fax +86-21-51816508
east@aagstucchi.hk

aagstucchi.it



EUTRAC Stromschiene GmbH
Volkmarstraße 18, D-12099 Berlin
Ph. +49 (0) 30 270009-0
Fax +49 (0) 30 270009-248
export@eutrac.de
service@eutrac.de

eutrac.de



Aggiornamento Febbraio 2023

February 2023 update

A. A. G.
STUCCHI

EUTRAC