

CASAMBI Lichtsteuerung DALI PS 20mA programmierbar

Artikel-Nr. 808686

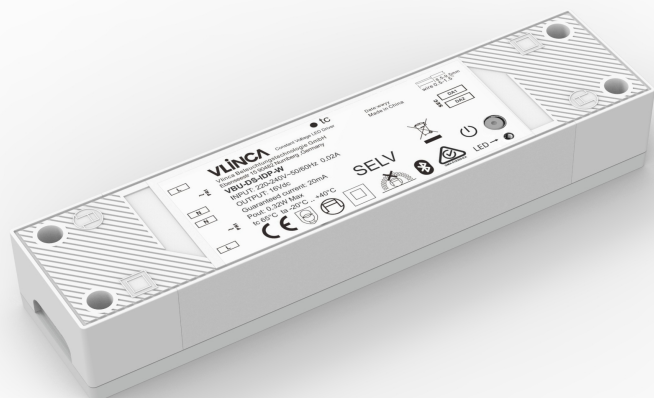

Warnings

- _ Risk of electrical shock, personal injury or death.
- _ Turn power off before installing the device.
- _ This device may only be installed and put into operation by qualified personnel.
- _ Check the information of the devices connected to the controller to see if they are compatible.
- _ If damage or malfunction should occur during operation, immediately turn power off and send device back to the factory for inspection. Do not open, modify or repair the device. It does not contain serviceable parts.

Product introduction

“VBU-DS-IDP-W” is a Casambi to DALI control device. It uses Bluetooth Low Energy communication to receive a command signal from the Casambi App and convert the command into DALI commands according to the selected fixture profile. Also, VBU-DS-IDP -W has an integrated DALI Bus Power Supply with 20mA guaranteed current , it can control up to 8 DALI LED drivers individually or by group.

There are many Casambi fixture profiles available for VBU-DS-IDP-W that include different control modes: Broadcast,

Short Address, Groups, DT6, DT8.

Fixture profiles

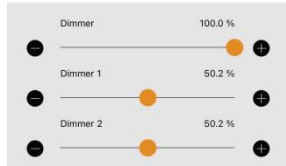
Profile#	Profile name in app	Description	Manual App Control	
34497	VBU-DS-IDP (1 ID-DT6)	DALI DT6 1xdimmer	Dimmer: A0 Dimmer1:A0	
34496	VBU-DS-IDP (2 ID-DT6)	DALI DT6 2 x dimmers	Dimmer: A0,A1 Dimmer1: A0 Dimmer2: A1	

34495	VBU-DS-IDP (3 ID-DT6)	DALI DT6 3 x dimmers	Dimmer: A0,A1,A2 Dimmer1:A0 Dimmer2:A1 Dimmer3:A2	
34494	VBU-DS-IDP (4 ID-DT6)	DALI DT6 4 x dimmers	Dimmer: A0,A1,A2,A3 Dimmer1:A0 Dimmer2:A1 Dimmer3:A2 Dimmer4:A3	
34493	VBU-DS-IDP (5 ID-DT6)	DALI DT6 5 x dimmers	Dimmer: A0,A1,A2,A3,A4 Dimmer1:A0 Dimmer2:A1 Dimmer3:A2 Dimmer4:A3 Dimmer5:A4	
34492	VBU-DS-IDP (6 ID-DT6)	DALI DT6 6 x dimmers	Dimmer:A0,A1,A2,A3,A4,A5 Dimmer1:A0 Dimmer2:A1 Dimmer3:A2 Dimmer4:A3 Dimmer5:A4 Dimmer6:A5	
34491	VBU-DS-IDP (7 ID-DT6)	DALI DT6 7 x dimmers	Dimmer:A0,A1,A2,A3,A4,A5,A6 Dimmer1:A0 Dimmer2:A1 Dimmer3:A2 Dimmer4:A3 Dimmer5:A4 Dimmer6:A5 Dimmer7:A6	

27731	VBU-DS-IDP (8 ID-DT6)	DALI DT6 8 x dimmers	Dimmer:A0,A1,A2,A3,A4,A5,A6,A7 Dimmer1:A0 Dimmer2:A1 Dimmer3:A2 Dimmer4:A3 Dimmer5:A4 Dimmer6:A5 Dimmer7:A6 Dimmer8:A7	
34490	VBU-DS-IDP (1 Group-DT6)	Control a group of DT6 luminaires	Dimmer:G0 Group0:G0	
34489	VBU-DS-IDP (2 Group-DT6)	Control 2 groups of DT6 luminaires	Dimmer:G0,G1 Group0:G0 Group1:G1	
34488	VBU-DS-IDP (3 Group-DT6)	Control 3 groups of DT6 luminaires	Dimmer:G0,G1,G2 Group0:G0 Group1:G1 Group2:G2	
34487	VBU-DS-IDP (4 Group-DT6)	Control 4 groups of DT6 luminaires	Dimmer:G0,G1,G2,G3 Group0:G0 Group1:G1 Group2:G2 Group3:G3	
34486	VBU-DS-IDP (5 Group-DT6)	Control 5 groups of DT6 luminaires	Dimmer:G0,G1,G2,G3,G4 Group0:G0 Group1:G1 Group2:G2 Group3:G3 Group4:G4	

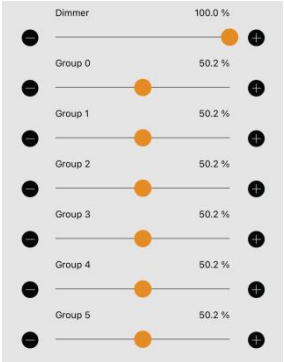
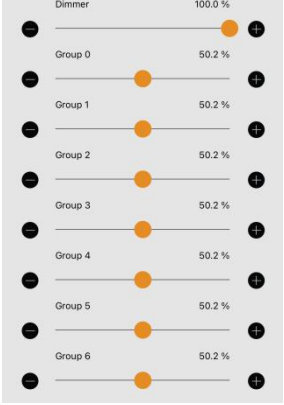
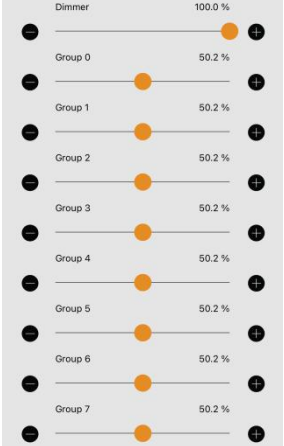
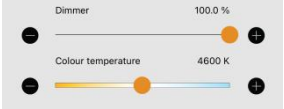
34485	VBU-DS-IDP (6 Group-DT6)	Control 6 groups of DT6 luminaires	<p>Dimmer:G0,G1,G2,G3,G4,G5 Group0:G0 Group1:G1 Group2:G2 Group3:G3 Group4:G4 Group5:G5</p>	
34484	VBU-DS-IDP (7 Group-DT6)	Control 7 groups of DT6 luminaires	<p>Dimmer:G0,G1,G2,G3,G4,G5,G6 Group0:G0 Group1:G1 Group2:G2 Group3:G3 Group4:G4 Group5:G5 Group6:G6</p>	
29188	VBU-DS-IDP (8 Group-DT6)	Control 8 groups of DT6 luminaires	<p>Dimmer:G0,G1,G2,G3,G4,G5,G6,G7 Group0:G0 Group1:G1 Group2:G2 Group3:G3 Group4:G4 Group5:G5 Group6:G6 Group7:G7</p>	
33203	VBU-DS-IDP (1 Group-DT8)	Control a group of DT8 luminaires	<p>Dimmer: for adjusting brightness of all luminaires in the group Colour temperature: for adjusting temperature of all luminaires in the group</p>	

Technical data

Nominal input voltage		220 ... 240 Vac
Input voltage range		198 ... 264 Vac
Input frequency		50 ... 60 Hz
Input current		≤ 20 mA
Starting time(220Vac, full load, 25°C)		< 500ms
No load Power consumption		< 0,5W
Power consumption standby		< 0,5W
Output control interface		DALI
Max. number of drivers connected		8
Firmware update		OTA (Over The Air)
Protections		Short circuit protection Overload protection No-load protection
Operating temperature range		-20°C ... +50°C
Max. casing temperature tc		65°C
Storage Temperature		-20°C ... +80°C
voltage accuracy		±10%
Ripple (220V,full load)		±5%
DALI	Bus voltage	14-16 VDC
	Guaranteed current	20mA
	Maximum current	70mA
RF	Communication interface	BLE
	Communication protocol	Casambi
	Operating frequencies	2402–2480 MHz
	Max. transmission power	+7 dBm
Wiring	Solid size	0,5 ... 1,5 mm ²
	Stranded size	30 ... 15 AWG
	Wire strip length	6,5mm
IP		IP20
Dimensions		146*35.5*28mm
Certifications		CE, RCM

Wiring diagram

Wired it according to the following wiring diagram.

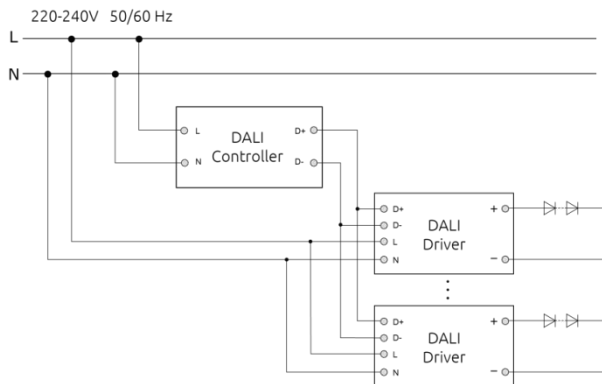

Change fixture profiles

- _ After wired the DALI controller, it can be seen in "Nearby devices".
- _ The default profile built in device is "VBU-DS-IDP (8 ID-DT6)".
- _ If need to change the fixture profile, make sure it is in unpaired status.
- _ Select "Nearby devices", tap "VBU-DS-IDP (8 ID-DT6)" icon, select "Change profile" (as in **Figure 1**).
- _ Change the fixture profile to your desired (as in **Figure 2**).
- _ After fixture profile is changed, click "check for updates" in the app to refresh the display.

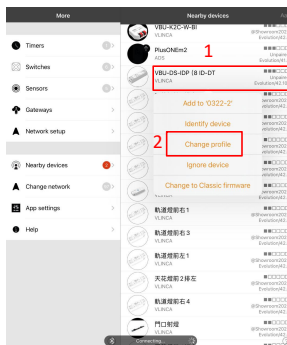

Figure 1



Figure 2

Button and LED indication

Reset button:

If the device is already paired to a network for which you don't have credentials and you wish to pair it to a new network, follow the steps in **Figure 3**. Then, using a needle to reach the inside reset button (as in **Figure 4**), and it will implement "Switch OFF and back ON again".

LED indication:

The light flashes once indicate the device is successfully restarted.

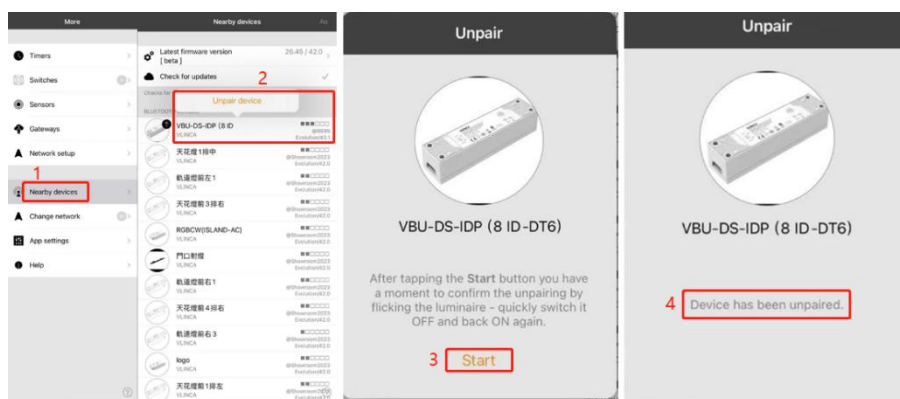

Figure 3

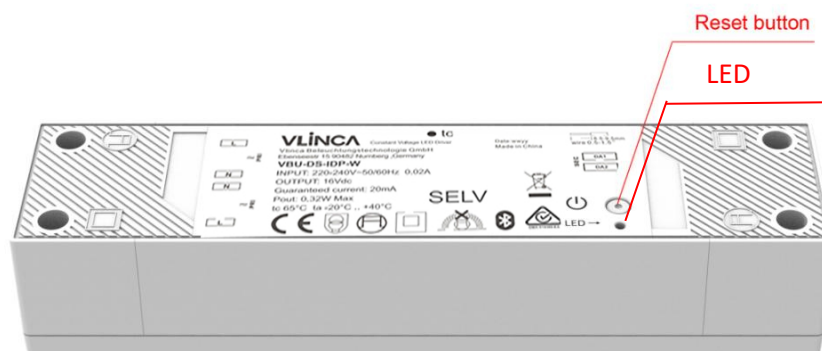

Figure 4

Scan DALI devices

_ After paired the controller into network, it is visible in "Luminaires" tab.

_ Double tap "VBU-DS-IDP" icon, tap "Details".

_ Scan DALI devices to update connected devices' short address, group address, device type, make sure they are coincident with the fixture profile features. i.e.

_ If the fixture is "control 4 DT6", then only the short address within 0~3 could be controlled.

_ If the fixture is "control 4 groups DT6", then only the group address 0-3 could be controlled.

_ If the fixture is "control a group of DT8", then only DT8 device could be controlled, in broadcast mode.



Make sure no DALI addresses conflict in the bus.



Do not assign a DALI driver to multiple groups.

 : short address : group address : device type

< Back VBU-DS-IDP (8 ID-DT)	
Fixture mode	DALI/VirtualDim,Elements
Model	VBU-DS-IDP (8 ID-DT6)
Vendor	VLINCA
Network ID	336c7fc09c2d
Unit ID	15
Firmware	Evolution/42.101
RSSI	-71 dBm
Unit condition code	0x82
Supports BT Long Range	Yes
DALI Configuration	>
Scan DALI devices	OK >
DALI:A0 [G0] DT6	0c >
DALI:A1 [G1] DT6	0c >
DALI:A2 [G2] DT6:8	02 >
DALI:A3 [G3] DT6	0c >
DALI:A4 [G0] DT6	0c >

Figure 5

DISPOSAL INSTRUCTIONS In line with EU

Directive 2012/19/EU for waste electrical and electronic equipment (WEEE), this electrical product must not be disposed of as unsorted municipal waste. Please dispose of this product by returning it to the point of sale or to your local municipal collection point for recycling.

COMPLIANCE STATEMENT

VLINCA declares that the VBU-DS-IDP-W fully complies with Directive 2014/53/EU.

Revision record

Version	Remark	Revision date
V1.0	Newly formulate	July 19, 2024